



2.01

Neoprene Sponge Sealing Tape



Page 48

3M 471 Vinyl Lane Marking Tape



Page 59

Vidaflex SD550 Silicone Coated Slewing



Page 32

Natural Rubber Insertion



Page 40

Flex 310M HT200 Powder Coating Adhesive



Page 6

Superwool High Temp. Insulation Blankets



Page 51

# About Us & This Catalogue

We are 100% Australian-owned and independent. Though the company's new, the people behind it are not. Together, we've got over 50 years experience in the industry and with our products specifically.

We use this experience to help with product selection, suggestions and to ensure that all of our custom fabricated work is done to meet your requirements. We're a little different to many other (primarily) online stores in that we don't just distribute products; oftentimes we fabricate them.



We started Swift Supplies on a simple premise; make industrial grade hardware and engineering supplies available to everyone.

To do this, we've used our shared knowledge, experience and relationships with some of the world's leading manufacturers so we can offer everyone access to solutions often reserved for bigger businesses with an advertised price.

We still have a long way to go though and are adding new products and sizes to our website each and every fortnight. We've always followed a simple philosophy with choosing these additions; add the products people ask us for.

## Catalogue Overview

We hope that this catalogue is useful to you. We've put it together following a lot of requests.

What took us so long is overcoming a couple of problems: our range is always growing, sizes do change and we couldn't fit every material and size in print.

Consequently, this catalogue does have a couple of limitations we'd like to point out up front:

- This Catalogue Features "Only" About 50% of Our Materials. Our Range is Always Growing and Changing.
- Technical Details and Specifications Presented Should Not Be Treated as a Substitute for Specific Technical Advice.
- Additional Information (Pricing, Quantity Breaks, Specifications, Videos, etc...) Is Available Online.

| Pages   | Products & Materials                      |
|---------|---|
| 4 - 10  | Adhesives & Sealants                      |
| 11 - 12 | Anti-Seize & Industrial Lubricants        |
| 13 - 21 | Chemicals, Sprays & Liquids               |
| 22 - 34 | Electrical Insulation, Conductors & Tools |
| 35 - 48 | Gaskets & Sealing                         |
| 49 - 55 | Heat Insulation                           |
| 56 - 57 | Plastics                                  |
| 58 - 61 | Tapes                                     |
| 62 - 63 | Tools, Specialised Hardware & Accessories |

## Some of the Brands We Work With...



& Many More.

# Custom Fabricated Parts & Solutions

At Swift, we cut, slit, saw, sew, machine and fabricate all kinds of parts every day. Many of these are the various sheet sizes, flange gaskets and tapes you can find on our website (and in this catalogue).



In addition to producing these parts, we are pleased to offer a full fabrication service for many of our materials. The following sections provide an overview of some of our capabilities. For more information on any, please do contact us.

## Tape Slitting and Conversion

Many of the sizes of various tapes listed in this catalogue are cut to size using our slitting facilities.

For several materials, this means that we can offer custom width rolls to suit your exact needs. If you do need a width that isn't listed (say, 74mm) just let us know and we'll do our best to assist.



## Gasket Cutting

Depending on the material, gaskets & washers can be produced using either precision knife-cutting or water-jet cutting.

The vast, vast majority of our materials are able to be supplied as cut gaskets on request. Gaskets can be produced to suit your drawings, sketches, dimensions or even from old gasket samples.



## Electrical Insulation Components Fabrication

For everything from small appliances to the largest stators, generators and transformers; we can produce a wide range of custom electrical insulation parts and solutions.

Using our wide range of materials, all kinds of slot wedges, insulating washers, isolation plates and a lot more can be produced to suit your specific application.



## Thermal Insulation Part Manufacture

To protect against and insulate heat, sometimes a custom solution is required. We can produce all kinds of pump covers, welding blankets, pipe insulation sleeves and more to suit your application.

Using one or more of our heat insulation materials and our fabrication facilities, all kinds of temperatures and applications can be covered.



## Precision Sheet Cutting

All but the largest sizes of all our rigid gasket, thermal and electrical insulation materials are cut to size in-house. This means we can also offer all kinds of custom cut sheets.

These can be either straight edged (saw) or far more complex designs with counter-sunk holes, cut outs & more (water cut and machined).

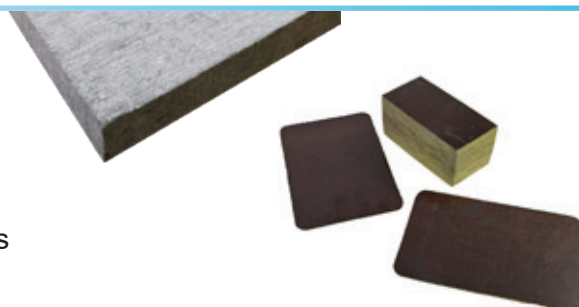

# Acrylic Adhesives & MMAs

## RK-1300 No-Mix Acrylic Glue

A very high strength adhesive that is perfect for joining metal sheets, ceramic, ferrites and many types of rigid plastic.

RK-1300 Acrylic Glue is fast curing, very easy to use and creates strong bonds that will last.



### Standard Sizes

60gm Pack

1kg Kit

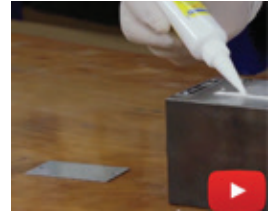

## Easy-Mix PE-PP 45 for Polyethylene & Polypropylene

A professional-quality adhesive that can glue polyethylene (PE), polypropylene (PP) and almost all other plastics (plus metal).

This MMA features an integrated primer, creates strong bonds and is very easy to use and apply.



### Standard Size

45ml Cartridge



## Easy-Mix RK-7000 Extended Cure Acrylic Glue

A very high strength glue, our Easy-Mix RK-7000 MMA has an extended cure time and is highly viscous.

It is highly compatible with plastic, metal, wood, ceramic and more. Highly viscous for use on vertical or complex bonding jobs.



### Standard Size

50gm Cartridge



## Easy-Mix RK-7300 Structural Acrylic Adhesive

A premium grade glue for the most demanding of applications.

Easy-Mix RK-7300 Acrylic Adhesive is able to join all kinds of low surface energy plastics and hard to bond materials.

High strength and long lasting.



### Standard Size

50gm Cartridge



## Plastic Bond

Designed especially for the fast, strong and lasting bonding of plastics to themselves and to other materials.

Plastic Bond is a high strength glue made from methyl methacrylate.

It is compatible with a variety of materials and surfaces.



### Standard Size

24ml Cartridge



## 3M Scotch-Weld 1300L Rubber & Gasket Contact Adhesive

|             |
|-------------|
| <b>Size</b> |
| 946ml Can   |

A high performance, professional-grade contact adhesive.

3M Scotch-Weld 1300L is a one-part adhesive used for bonding Neoprene, SBR, Butyl, Metal, Wood and more. Very fast cure and heat resistant up to 149°C.



## SC 2000 Cold Vulcanising Cement Adhesive + UTR20 Hardener

|             |
|-------------|
| <b>Size</b> |
| 1kg Kit     |

Industrial grade adhesive that cures at room temperature.

SC 2000 Cold Vulcanising Cement is widely recognised as a world leading adhesive and creates high strength, permanent bonds.



## GMK 2510 High Strength Contact Adhesive

|              |
|--------------|
| <b>Sizes</b> |
| 324gm Kit    |
| 690gm Kit    |

Two-part glue for creating very high strength bonds across larger surface areas.

GMK 2510 is perfect for joining metal, rubber (especially EPDM), insulation materials, textiles and more.



## GMK 2410 Rubber Metal Contact Adhesive

|              |
|--------------|
| <b>Sizes</b> |
| 185gm Tube   |
| 350gm Can    |
| 700gm Can    |
| 5kg Can      |
| 25kg Can     |

High quality contact adhesive designed for larger surface areas.

GMK 2410 Rubber Metal Adhesive works very well with leather, felt, insulation materials, textiles, wood and many plastics in addition to rubber and metal.

|                  |            |                  |                                   |
|------------------|------------|------------------|-----------------------------------|
| Contact Adhesion | 10 Minutes | Temp. Resistance | -40°C to +80°C                    |
| Final Strength   | 24 Hours   | Consumption      | 250-350g/m <sup>2</sup> (approx.) |



## Adhesive Accessories & Equipment

To compliment our huge range of glues, sealants and adhesives; we are pleased to stock a selection of Adhesive Accessories and Equipment.

This category includes everything from adhesive primers for the toughest of materials through to quality dispensing guns and precision dosing tips. All are made to make your bonding job easier and more efficient.

More information on all is available via [swiftsupplies.com.au/adhesive-accessories-equipment-range/](http://swiftsupplies.com.au/adhesive-accessories-equipment-range/)



Primer P400 for Polyolefins



Quadro Easy-Mix Nozzles



Activator Sprays for Super Glues

# Elastic Adhesives & Sealants

## Aqua-Flex Underwater Adhesive Sealant



|         |                      |
|---------|----------------------|
| Size    | 310ml Cartridge      |
| Colours | Black, White or Grey |

A special kind of adhesive sealant that can be applied to wet, damp or even submerged surfaces.

Aqua-Flex Underwater Sealant and Adhesive bonds to most types of materials and is strong and long lasting.



## Black Seal RTV Silicone for Oil & Grease



|        |              |
|--------|--------------|
| Sizes  | 85ml & 310ml |
| Colour | Black        |

A very high quality silicone with excellent compatibility with oils and grease.

Black Seal is perfect for sealing gearboxes, oil sumps, pumps, axles, tanks and flanges. It withstands temperatures up to 300°C.

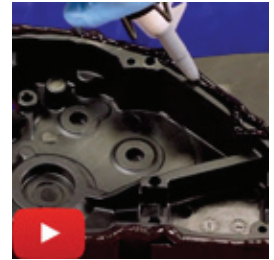

## Flex 310M HT 200 High Temp. Adhesive Sealant



|        |                 |
|--------|-----------------|
| Size   | 310ml Cartridge |
| Colour | Grey            |

HT 200 is a high temperature grade of MS Polymer that withstands 200°C for 30 minutes.

It's grey, bonds well to most surfaces, is free of silicone and is ideal for bonding or sealing parts that need to be powder coated.



## More Silicones, MS Polymers, Urethanes & Elastic Adhesives

The styles shown on this page are but a small portion of our huge range of different types of elastic adhesives and sealants.

This range is constantly growing and covers everything from general-purpose silicones & paintable urethanes, through to premium-grade Viton adhesives.

For help with type selection or more information please contact us or visit the link at the bottom of this page.



HT300 High Temperature Silicone



Momentive RTV100 Silicone



Flex 310M 2K MS Polymer



Silicone N10 Neutral Cure



Flex 310 PU Polyurethane



Fluorodyn Viton Caulk

## Epoxy Repair Sticks

Our Epoxy Repair Sticks are fast, simple and incredibly effective. Designed for quick patches, gap filling or bonding work that will last, these epoxy putties are very easy to use and require no special equipment.

Our Repair Stick Range covers all kinds of repairs with types that can be applied underwater, have food grade approval or will withstand up to 300°C.



| Repair Stick Type:         | Aluminium | Aqua | Concrete | Copper | Multi | Plastic | Stainless | Steel | Titanium | Wood |
|----------------------------|-----------|------|----------|--------|-------|---------|-----------|-------|----------|------|
| Metal                      | ++        | ++   | +        | ++     | ++    | +       | ++        | ++    | ++       | +    |
| Hard Plastics*             | +         | ++   | +        | +      | ++    | ++      | +         | +     | +        | +    |
| Wood                       | +         | +    | +        | +      | +     | +       | +         | +     | +        | ++   |
| Derived Timber Products    | +         | +    | +        | +      | +     | +       | +         | +     | +        | ++   |
| Fibre Reinforced Materials | +         | +    | +        | +      | +     | ++      | +         | +     | +        | +    |
| Glass, Ceramic             | +         | ++   | +        | +      | ++    | +       | +         | +     | +        | +    |
| Stone / Concrete           | +         | ++   | ++       | +      | ++    | +       | +         | +     | +        | +    |
| Rubber Elastomers          | -         | -    | -        | -      | -     | -       | -         | -     | -        | -    |

++ Highly Compatible

+ Compatible

- Not Suitable

\*Except for LSE plastics & other fluorinated hydrocarbons.

## Easy-Mix HT-180 High Temperature Epoxy Adhesive

|        |          |
|--------|----------|
| Size   | 50ml     |
| Colour | Black    |
| Nature | Pasty    |
| Temp.  | 180°C    |
| Filler | Minerals |

High temperature resistant epoxy glue that withstands 180°C continuous or 230°C short-term.

Easy-Mix HT 180 is strong, impact and shock resistant and able to cover larger gaps (4mm). Ideal for bonding parts that will be powder coated or exposed to heat.



## Fast Metal Minute Adhesive

|        |           |
|--------|-----------|
| Size   | 24ml      |
| Colour | Dark Grey |
| Nature | Pasty     |
| Temp.  | 145°C     |
| Filler | Steel     |

A fast curing, high strength epoxy glue for joining metals, plastic, ceramics, glass, wood, stone and more.

Fast Metal Minute Adhesive requires no measuring, has a very pasty consistency and sets fast to form strong, long lasting joins.

Needs no special tools. Mixing nozzles are optional.



## Easy-Mix S 50 Epoxy Adhesive Fast Curing, Liquid Adhesive

|        |             |
|--------|-------------|
| Size   | 50ml        |
| Colour | Transparent |
| Nature | Liquid      |
| Temp.  | 80°C        |
| Filler | None        |

High temperature resistant epoxy glue that withstands 180°C continuous or 230°C short-term.

Easy-Mix HT 180 is strong, impact and shock resistant and able to cover larger gaps (4mm). Ideal for bonding parts that will be powder coated or exposed to heat.



# Plastic Metals

Ideal for fast, cost effective and durable repairs, bonding and coating of all kinds of materials. The Weicon Plastic Metal range includes types of epoxies that can be used for all kinds of DIY, industrial, construction and commercial applications.



This range of industrial-grade products includes everything from fast setting, high strength putties to specialised types of metal filled epoxy for wear protection, corrosion prevention and large area bonding.

There are grades capable of extreme temperature resistance (280°C), withstanding very high degrees of abrasion, creating high strength bonds, or rebuilding broken metal parts.

## Plastic Metal A & Plastic Metal B Steel Filled Epoxies

|        |                                 |
|--------|---------------------------------|
| Sizes  | 500g, 2kg                       |
| Colour | Dark Grey                       |
| Nature | Type A: Pasty<br>Type B: Liquid |
| Temp.  | -35°C to +120°C                 |
| Filler | Steel                           |

Among our two most popular forms of plastic steel, Types A and B are both made with steel filled epoxy resin, stick to most surfaces and materials and set very hard (90 Shore D).

Widely used for repair and reconditioning work, Plastic Metal A is pasty while Plastic Metal B is more Liquid.



## Plastic Metal C Heat Resistant Liquid Epoxy

|        |                 |
|--------|-----------------|
| Sizes  | 500g, 2kg       |
| Colour | Grey            |
| Nature | Viscous, Liquid |
| Temp.  | -35°C to +220°C |
| Filler | Aluminium       |

A high temperature aluminium filled epoxy resin that sets hard with good strength.

Plastic Metal C has a liquid consistency, withstands 220°C and can be used for mould making, bonding, coating and more.



## Plastic Metal HB 300 Steel Filled Epoxy

|        |                 |
|--------|-----------------|
| Sizes  | 1kg             |
| Colour | Dark Grey       |
| Nature | Pasty           |
| Temp.  | -35°C to +200°C |
| Filler | Steel           |

An extremely strong, tough and long-lasting epoxy compound that is used for industrial repair work around the world.

HB 300 is a two-part, steel filled epoxy that is used for bonding, filling, lining, sealing and rebuilding damaged parts and surfaces. It handles up to 200°C (spikes to 280°C).



## Plastic Metal Ceramic BL Wear Resistant Epoxy

|        |                 |
|--------|-----------------|
| Sizes  | 500g, 2kg       |
| Colour | Blue            |
| Nature | Viscous, Liquid |
| Temp.  | -35°C to +180°C |
| Filler | Mineral         |

A pourable & brushable epoxy coating that protects surfaces from abrasion and wear.

Ceramic BL is used to form a tough, long lasting coating to protect all kinds of components, surfaces and parts. Heat resistant to 180°C.

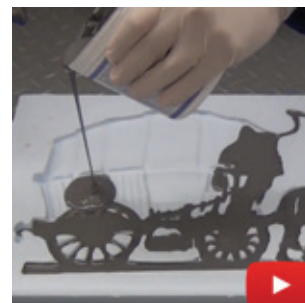

## Other Plastic Metal Grades and Selection Assistance

Our Plastic Metal Range currently includes 15 different grades. We've worked with these quality epoxies for years and we are available to help with product selection.

We back up our experience with a full technical department in Germany to ensure you can find the best product for your requirements.





# Super Glues (Cyanoacrylates)

## VA 8406

A very fast curing glue that is compatible with a large variety of materials.

Weicon VA 8406 Super Glue is highly reliable, creates strong bonds and can be used in a range of applications. It's particularly good at bonding plastics and rubbers.

| Standard Sizes |      |      |       |
|----------------|------|------|-------|
| 12gm           | 30gm | 60gm | 500gm |

## VA 30 Black

A super glue with greater residual elasticity, impact resistance, peel strength and temperature tolerance (140°C).

This grade bonds well to most materials and is ideal for high humidity areas or those where temperatures change a lot.

| Standard Sizes |      |
|----------------|------|
| 12gm           | 30gm |

## VA Contact Gel

A very thick and pasty type of cyanoacrylate, Contact Gel Super Glue works well with almost all materials and is slow curing to allow you to position objects after applying the glue.

It's perfect for bonding porous materials like leather, cork or sponge.

| Standard Sizes |      |
|----------------|------|
| 20gm           | 30gm |

## VA 100 Universal

A versatile super glue that works with most material types without sacrificing bond strength.

VA 100 is transparent and works with rubbers, metals, glass, ceramic, plastics, leather, wood and more.

| Standard Sizes |      |      |      |
|----------------|------|------|------|
| 3gm            | 12gm | 30gm | 60gm |

## VA 180 HT High Temp.

A super glue with greater residual elasticity, impact resistance, peel strength and temperature tolerance (140°C).

This grade bonds well to most materials and is ideal for high humidity areas or those where temperatures change a lot.

| Standard Size |
|---------------|
| 30gm          |

## VM 120

A special kind of super glue developed especially for bonding metal parts and components.

VM 120 is methyl ester based and has a slightly extended cure time to allow you a few seconds to position the parts after you apply the glue.

| Standard Sizes |      |       |
|----------------|------|-------|
| 30gm           | 60gm | 500gm |

|                                | VA 8406              | VA 30                | Contact Gel          | VA 100               | VA 180 HT            | VM 120               |
|--------------------------------|----------------------|----------------------|----------------------|----------------------|----------------------|----------------------|
| Colour                         | Colourless           | Black                | Colourless           | Colourless           | Colourless           | Colourless           |
| Viscosity (mPa·s)              | 20 - 50              | 250 - 300            | 60,000 - 90,000      | 60 - 120             | 300 - 400            | 100 - 300            |
| Shear Strength Steel (Blasted) | 22 N/mm <sup>2</sup> | 22 N/mm <sup>2</sup> | 21 N/mm <sup>2</sup> | 20 N/mm <sup>2</sup> | 14 N/mm <sup>2</sup> | 25 N/mm <sup>2</sup> |
| Rigid PVC                      | 14 N/mm <sup>2</sup> | 14 N/mm <sup>2</sup> | 13 N/mm <sup>2</sup> | 13 N/mm <sup>2</sup> | 13 N/mm <sup>2</sup> | 12 N/mm <sup>2</sup> |
| Initial Adhesion Rubber        | < 5 Sec.             | 5 - 10 Sec.          | 20 - 30 Sec.         | 5 - 20 Sec.          | 5 - 20 Sec.          | 10 - 60 Sec.         |
| Temperature                    | -50°C   +80°C        | -50°C   +140°C       | -50°C   +80°C        | -50°C   +80°C        | -55°C   +180°C       | -50°C   +120°C       |

## Plastic Bonding Kit

Bond even the most difficult types of plastic with our professional-quality plastic bonding kit.

Each kit contains a specially selected industrial grade super glue and our specialised Contact Primer for Polyolefins.

| Standard Sizes |           |
|----------------|-----------|
| 12gm Glue      | 30gm Glue |



# Threadlockers & Retaining Adhesives

## Weiconlock AN 302-43

| Standard Sizes |      |
|----------------|------|
| 20ml           | 50ml |



A high viscosity and medium strength general-purpose thread locking adhesive. Weiconlock AN 302-43 is blue in colour and has been approved by DVGW for use with gas connections and KTW for use with drinking water.

## Weiconlock AN 306-30

| Standard Sizes |       |
|----------------|-------|
| 20ml           | 200ml |

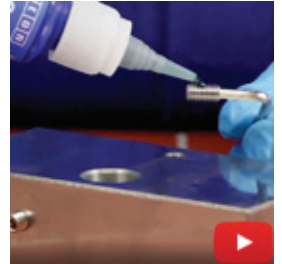

High viscosity, high strength anaerobic adhesive able to be used not just on metal, but on many types of passive materials. Weiconlock AN 306-30 works with zinc, aluminium, nickel, high alloyed steel and many plastics. Very fast curing.

## Weiconlock AN 305-67

| Standard Sizes |       |
|----------------|-------|
| 50ml           | 200ml |

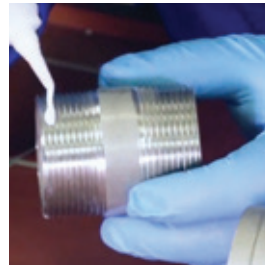

Low strength, high viscosity liquid gasket and pipe sealing adhesive. Weiconlock AN 305-67 is enhanced with PTFE for excellent sealing and is non-marking. White in colour, it is fast and simple to disassemble when required.

## More Thread Lockers, Pipe Sealants and Liquid Gasket Adhesives

Our Weiconlock range are all Anaerobic Adhesives; special types of adhesive that cure only when deprived of air. This makes them perfect for sealing and locking threaded connections, close fitting pipes, bearing housings and other precision metal parts. They can even be used to create liquid gaskets on things like compressors and other closely mated flange connections.

Our range of Weiconlock Anaerobic Adhesives include grades suitable for all kinds of applications and are all German engineered and made. Our online filters (e.g. Strength, Viscosity, Size) make finding the right grade fast and easy. Of course, we're here to assist should you wish to discuss further.

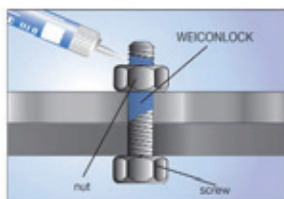

Threadlockers  
10+ Styles



Retaining Adhesives  
9+ Styles

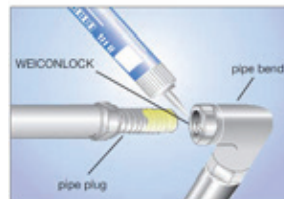

Pipe & Fitting Adhesives  
10+ Styles



Flange Sealing & Gasketing  
9+ Styles

## Anti-Seize High Tech

Completely free of metal. Used for lubricating and protecting parts, it can withstand 1400°C, is NSF approved for food applications and provides quality, lasting performance.

Applications for Anti-Seize High Tech, Metal Free Compound

- Lubricating bolts, screws and threaded connections.
- Lubricating and protecting all kinds of metal parts including stainless steel, brass, bronze, copper, mild steel and more.
- Wherever nickel based anti seize must not be used for health reasons.
- Wherever dark metal based anti seize should not be used for optical reasons.
- Where metal containing pastes may cause electrolytic reactions.
- Wherever a dielectric anti seize compound is required.
- Lubrication and protection of closely fitted metal parts in the food, pharmaceutical and water sectors.
- Lubricating all kinds of metal parts, protecting them from corrosion and preventing seizing or cold welding.



| Standard Sizes |       | Temperature Resistance        | -40°C to +1400°C      |
|----------------|-------|-------------------------------|-----------------------|
| 5gm            | 450gm | Base Oil                      | Medicinal Oil         |
| 30gm           | 500gm | Colour                        | White                 |
| 85gm           | 1kg   | Density @ 20°C                | 1.42g/cm <sup>3</sup> |
| 120gm          |       | Coefficient of Friction Total | 0,13 μ                |



## Copper Anti-Seize



|                               |                      |
|-------------------------------|----------------------|
| Temperature Resistance        | -20°C to +1100°C     |
| Base Oil                      | Mineral Oil          |
| Colour                        | Copper               |
| Density @ 20°C                | 1.1g/cm <sup>3</sup> |
| Coefficient of Friction Total | 0,12 μ               |

| Standard Sizes |       |
|----------------|-------|
| 30gm           | 200ml |
| 85gm           | 400gm |
| 120gm          | 500gm |

A tried and tested lubricating, protecting and separating compound. Weicon Copper Anti Seize Paste adheres to most surface types, withstands temperatures up to 1100°C and is extremely effective.

## Anti-Seize Standard



|                               |                       |
|-------------------------------|-----------------------|
| Temperature Resistance        | -180°C to +1200°C     |
| Base Oil                      | Synthetic Oil         |
| Colour                        | Anthracite            |
| Density @ 20°C                | 1.16g/cm <sup>3</sup> |
| Coefficient of Friction Total | 0,14 μ                |

| Standard Sizes |       |
|----------------|-------|
| 30gm           | 200ml |
| 120gm          | 500gm |

Made from finely ground metallic compounds and a synthetic oil lubricant. It provides protection against wear, prevents seizure, protects against corrosion and is very long lasting.

# Silicone Grease & Industrial Lubricants

## Silicone Grease

NSF Approved for Food Grade Applications, BAM Approved for Oxygen Service. Our Silicone Grease is typically used on gaskets, valves, seals, O-rings, plastics, rubber or machine parts. It is a very versatile product that combines high performance with exceptionally long service.



Applications for our Silicone Lubricating Grease.

- Lubricating O-Rings and Seals.
- Preserving Rubber.
- As an electrical insulation and filling compound.
- Plastic Part Lubrication.
- Grease for Machine Equipment and Slow Rotating Bearings.
- Valve Grease.
- Preserving rubber seals, O-Rings and gaskets.
- As a lubricating agent for stressed electrical connections and terminals.

| Standard Sizes     |                                  |
|--------------------|----------------------------------|
| 85gm               | 1kg                              |
| Temperature        | -50°C to +200°C                  |
| Composition        | Pyrogenic Silica<br>Silicone Oil |
| Colour             | Transparent                      |
| Density @ 20°C     | 0.98g/cm <sup>3</sup>            |
| Worked Penetration | 222 - 310 1/10mm                 |

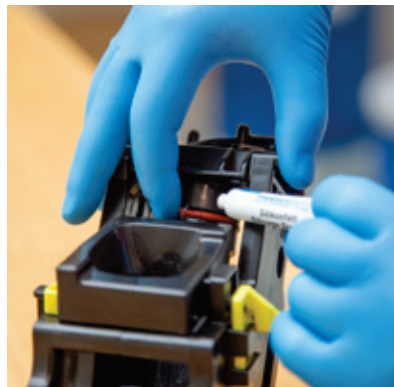

## AL-W Underwater Marine Grease

| Standard Sizes |     |
|----------------|-----|
| 400gm          | 1kg |

|             |                |
|-------------|----------------|
| Assignment  | NLGI Class 1-2 |
| Temperature | -25°C to +80°C |



A specialised, industrial-grade lubricant designed specifically for marine, wet-area and underwater lubrication. AL-W Underwater Marine Grease can be used with most types of equipment & provides excellent corrosion protection & lubrication.

## Bio-Cut Cutting Oil Lubricant

| Standard Sizes |       |
|----------------|-------|
| 400ml          | 500ml |

|             |                 |
|-------------|-----------------|
| Colour      | Slightly Opaque |
| Temperature | +200°C          |



A professional-quality cutting oil, Weicon Bio-Cut significantly reduces friction and enables superior cutting and finishing. Suitable for use in a variety of metal working applications and trusted around the world.

Made in Germany, Bio-Cut is bio degradable and contains no mineral oil. It is used on all types of metal and can be used for drilling, turning, milling, grinding, sawing as well as reaming, metal forming and threading work.

## Adhesive Spray

Adhesive Spray is the fast, simple and easy way to bond large, lightweight surfaces and materials.

This spray works with most types of surfaces and materials and makes permanent bonding, mounting and fixing simple.



## Adhesive Spray Extra Strong

The easy way to create strong, permanent bonds.

Adhesive Spray Extra Strong is very easy to use and works with most types of materials and surfaces.



## Adhesive Spray For Detachable Joints

A fast-acting spray adhesive that allows for parts to be positioned after application.

This spray is transparent, does not discolour and can be used for temporary or permanent bonding. Ideal for crafts, DIY & professionals.



## 3M 74 Foam Fast Spray Adhesive

A fast tacking industrial grade adhesive spray that is ideal for bonding foams and fabrics.

3M Foam Fast Spray Adhesive creates soft (non-yellowing) bond lines and can be used with a wide range of materials.



## 3M 90 Hi-Strength Spray Adhesive

A strong, permanent spray-on adhesive that can be used with wood, decorative laminates, metal, fabric and many types of rubber and plastic.

3M 90 Hi-Strength Spray Adhesive is fast drying and very easy to use.

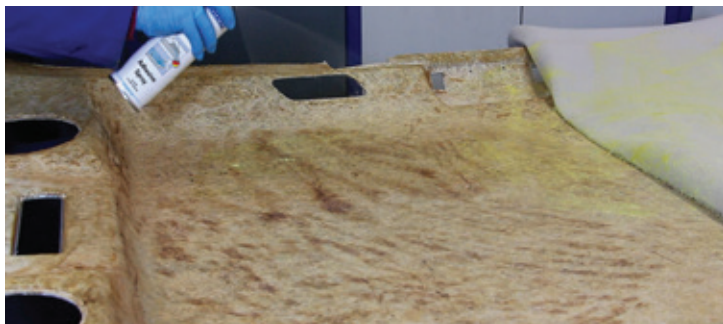

Adhesive Spray

Adhesive Spray Extra Strong



Adh. Spray Detachable



Adhesive Spray Extra Strong



Adhesive Spray Extra Strong

# Adhesive Lubricant & Grease Sprays

## Chain and Rope Lube Spray

An industrial lubricant spray with very strong adherence.

Ideal for lubricating wire ropes, chains and other types of equipment.

It has excellent penetration properties, suppresses noise and repels water.



## PTFE Fluid Spray – Dry Lubricant, NSF Approved

Creates a dry, PTFE-rich film with low friction and good anti-adhesive properties.

PTFE Fluid Spray is NSF H2 Approved for use in the Food and Beverage sectors and is easy to use, highly effective and very long lasting.



## Spray-On Grease NSF H1

NSF approved for use in food grade applications, our Spray-On Grease H1 effectively reduces friction on all kinds of equipment.

Odourless, tasteless and able to withstand up to 160°C.



## Spray-On Grease White

An effective, long-lasting spray-able grease that is white in colour for easy identification of treated areas and continued performance.

Spray-On Grease White has high adhesion, ageing and pressure resistance and provides wear reduction.



## Top-Lube Spray

A transparent, adhesive lubricant. Top-Lube Spray has excellent penetration and creeping properties and provides permanent lubrication through its high adhesive force.

Used on all types of gears, springs, bolts, bearings and more.



## Top-Lube Fluid Spray

A high quality, long-lasting lubricating spray NSF approved for use in the food and beverage sectors.

Top-Lube Fluid has excellent bond strength, a high lubricating effect, repels water and suppresses noise. Used on all kinds of moving parts.



## Universal Spray-On Grease with MoS2

A versatile, high-performance lubricant that has a wide range of applications.

Universal Spray-On Grease (MoS2) is a black, moly coating that is high pressure resistant and very long lasting. Suitable for use with all kinds of materials and parts.



Spray-On Grease White



Universal Spray-On Grease



Spray-On Grease H1



Spray-On Grease White

# Lubricating & Multi-Functional Sprays & Liquids

## AT-44 All-Round Lubricant

A professional-quality spray that combines lubrication, preservation, moisture displacement, rust prevention and cleaning powers into one.

AT-44 All-Round Lubricating Spray is powerful, long lasting and very easy to use.



## Fitting Spray

A very effective lubrication spray for hinges, joints and fittings.

Our Fitting Spray is free of silicones and solvents and reduces wear and friction, protects against corrosion, is weather resistant and suppresses squeaks.



## PTFE Spray

A highly effective lubricating spray based on PTFE. Weicon PTFE Spray is a dry film lubricant that reduces friction, wear and adhesion.

It is grease-free, water-repellent and anti-corrosion with a high PTFE content and long lasting performance.



## Rust Loosener & Contact Spray

A great option for loosening surface rust or rust on small parts, Rust Loosener and Contact Spray also dispels moisture, protects against corrosion and is an excellent metal cleaner.

This versatile spray is ideal for anyone in production or maintenance.



## Rust Loosener Fluid Spray

A high quality penetrating oil that effectively penetrates & loosens rust, corrosion and oxidation to free seized parts.

NSF H1 Approved for use in food grade applications with good cleaning, corrosion protection properties.



## W44T Multi-Spray

An incredibly versatile spray that combines lubrication, penetration, cleaning, preservation, rust protection & water-displacement.

This high-performance spray will have a use in any workshop, garage or facility.



## W44T Multi-Spray Fluid

A powerful and versatile food grade oil based lubricant that combines excellent penetration, cleaning, rust removal, water displacement and corrosion protection into one, easy to use spray.

NSF H1 Approved for the Food & Beverage Sector.



PTFE Spray



W44T Multi-Spray (Dual Nozzle Version)

# Cleaning, Care & Protection Sprays

## Citrus Cleaner Spray

Citrus Cleaner is used to clean metal, plastic, glass, ceramic and many painted or lacquered surfaces and is pH neutral, non-corrosive and incredibly versatile.

High isopropyl content ensures cleaning and disinfection in one spray.



## Cleaner Spray S

An extremely powerful cleaner and degreaser, Cleaner Spray S can be used for cleaning all kinds of different surfaces and parts and evaporates without leaving behind any residues.

Made in Germany, this versatile cleaning spray is available in 500ml cans.



## Cockpit Spray

Engineered to lubricate, protect and enhance vehicle interiors.

Cockpit Spray creates a permanent, invisible film that rejects water, repels dust and improves the appearance of even older surfaces.



## Compressed Air Spray

A fast, simple and reliable way to clean all kinds of sensitive components and parts.

Our Weicon Compressed Air Spray is fast, reliable and can be used in all kinds of areas. Supplied with an extension nozzle for hard-to-reach areas.



## Electro Contact Cleaner Spray

Specially formulated, professional-grade cleaner for electrical parts and connections.

Electro Contact Cleaner effectively removes dirt, dust, oxide and sulphide layers and reduces voltage loss and the potential for contaminant-assisted arcing.



## Foam Cleaner Spray NSF

Designed for the food, beverage and pharmaceutical sectors.

Foam Cleaner Spray has NSF Approval and is used for cleaning everything from scales and conveyor belts to touchscreens and view panels.



## Metal-Fluid Spray & Liquid

A special fluid that cleans, cares for and protects all kinds of metal surfaces indoors or outdoors. Metal-Fluid is NSF approved for food grade applications and can be used in a whole range of areas.

| Standard Sizes |       |
|----------------|-------|
| 400ml          | 500ml |



## Multi-Foam Spray

A powerful cleaner that is fast, simple and easy to use.

Multi-Foam can be used on all kinds of surfaces and effectively removes dirt, dust and grime and leaves behind no residues. Suitable for use in all kinds of applications.



Multi-Foam



# Cleaning, Care & Protection Sprays

## Parts and Assembly Cleaner

A very strong, powerful cleaning spray for heavily soiled parts and surfaces.

Parts and Assembly Cleaner is strong enough to clean away oily, coarse and greasy contamination on tools and surfaces. High flash point of >60°C.



## Plastic Cleaner Spray

Designed specifically for use on sensitive surfaces, Plastic Cleaner Spray is fast and effective.

It cleans plastic, rubber, powder coated and lacquered surfaces and evaporates without leaving residues. Available in 500ml easy-to-use aerosols.



## Sealant and Adhesive Remover

A powerful solvent that removes old, hardened residues from all kinds of adhesives and sealants.

Works on all kinds of surfaces and can also be used to strip paints and lacquers. Fast, effective and very easy to use.



## Stainless Steel Care Spray

A cleaning, polishing and protective spray combined into one.

Stainless Steel Care Spray cleans stainless surfaces and leaves behind a protective film that is anti-static, repels water, and prevents dirt, grime and fingerprint marks.



## Surface Cleaner Spray

A versatile cleaner, Surface Cleaner Spray is perfect for preparing parts and surfaces before they are bonded, sealed or painted.

It can be used on almost all types of material surfaces and evaporates without leaving behind any messy residues.



## Workshop Cleaner

A strong, versatile and effective cleaner that can be diluted to suit your requirements. Workshop Cleaner cleans and degreases almost all surface types and is free of solvents and bio-degradable.



| Standard Sizes |      |
|----------------|------|
| 500ml          | 10 L |



Sealant & Adhesive Remover



Stainless Steel Care



Part & Assembly Cleaner

# Rust Prevention & Anti-Corrosion

## Aluminium Spray A-100 - Abrasion Resistant

A specialised spray designed to restore, coat and protect metal surfaces.

A-100 is made with high purity aluminium pigments and creates a surface coating that not only looks good, but protects against corrosion and abrasion.



## Aluminium Spray A-400 - Bright Grade

Used to coat, enhance and protect all kinds of metal surfaces from corrosion.

A-400 provides a bright surface finish and is ideal for restoration and coating work in the automotive, marine, DIY, hobby, HVAC and engineering sectors.



## Brass Spray

A highly effective brass-coloured spray used on all kinds of metal surfaces.

Brass spray is very simple to use, long lasting and is ideal for repairs, decorating, transforming old metal parts and surfaces and repairs to yellow chrome-plated surfaces.



## Copper Spray

An easy to use, long lasting and very effective metal spray.

Copper Spray is made with real, high-purity copper pigments and creates a lasting coat that looks just like copper whilst also resisting corrosion.



## Stainless Steel Spray

Our Stainless Steel Spray is made with high purity stainless pigments, works on most surfaces and is very long lasting.

It looks just like matt finish stainless, protects against corrosion, withstands chemicals and can be used indoors or outdoors.



## Stainless Steel Spray - Bright Grade

A brighter grade of Stainless Steel Spray that has a finish similar to treated stainless (V2A, V4A). This quality spray is able to be used with most materials, is extremely corrosion resistant and ideal for restoring, protecting or decorating.



## Corro-Protection Spray

Coats and protects all kinds of surfaces from rust and corrosion.

Corro-Protection Spray creates a dry, waxy film that prevents moisture reaching the protected part thereby eliminating the chance of corrosion. Perfect for seldom used parts and tools.



Corro-Protection Spray



Aluminium A-100



Copper Spray



Stainless Steel Spray

## Galva Spray

Professional-Grade Rust Protection. Our Galva Spray is made with a combination of high-purity Zinc and Aluminium and provides very long-lasting corrosion protection for all kinds of metal.

Colour matched to hot dip galvanised metal.



## Zinc-Alu Spray

Quality corrosion protection colour matched to hot dip galvanised parts.

Our Zinc-Alu Rust and Corrosion Protection Spray is made with high purity Zinc and Aluminium and provides lasting protection for metal.



## Zinc Spray - Bright Grade

A very high quality and long lasting form of corrosion protection.

Zinc Spray Bright Grade is coloured to match new hot dip galvanised surfaces, can be used indoors and outdoors and protects all types of metal parts and surfaces.



## Zinc Spray

Very high quality corrosion protection spray made with 99.9% pure Zinc Flakes.

Zinc Spray adheres to all kinds of metal and creates a permanent protective layer that prevents rust and corrosion. Coloured to match the appearance of slightly-weathered zinc.



## Rust Converter Spray & Liquid

A special solution that permanently neutralises rust and creates a base coat in just one process.

Rust Converter can be used on all kinds of rusted metal and can be painted over once dry.

| Standard Sizes |     |     |
|----------------|-----|-----|
| 400ml          | 1kg | 5kg |



## Rust Protection 2000 Plus

A permanent rust and corrosion prevention solution available in two shades of grey.

Rust Protection 2000 Plus Spray is extremely long lasting, abrasion and weather resistant. It is used to protect all kinds of metal parts and surfaces.



Zinc Spray - Bright Grade



Galva Spray



Zinc Spray

# Solvents & Release Agent Sprays & Liquids

## Alu Grinding Protection Spray

A specialised spray used on all kinds of grinding and sanding abrasives.

Alu Grinding Protection Spray prevents clogging and acts as a cooling lubricant on the abrasive to increase useful life by up to 350%.



## Chewing Gum Remover Spray

The clean and easy way to remove old chewing gum.

Chewing Gum Remover Spray freezes the gum to break the adhesive bond and makes clean removal easy.

Works with most types of surfaces.



## Label Remover Spray

Fast and highly effective; Label Remover Spray makes removing adhesive labels and adhesive residues easy.

It can be used on glass, metal, wood, plastic, foil and most other surfaces types.



## Mould Release Agent Spray

A silicone free sliding and release agent with excellent anti-adhesive properties.

Mould Release Agent Spray is used anywhere you need to stop adhesion to plastic or metal surfaces, tools or moulds.



## Mould Release Wax P500

A high quality mould release wax from Weicon in Germany.

This extremely effective release agent is compatible with both Epoxy and Urethane Casting Compounds and perfect for casting with rough or porous surfaces. Available in two sizes.



## Rust Shock Spray

A fast acting and high-powered spray.

Rust Shock is used on rusted bolts, fasteners and threaded connections to break the bonds within the rust and make disassembly easy.



Rust-Shock



Label Remover



Alu-Grinding Protection



Mould Release Agent



Chewing Gum Remover

# Special-Purpose Sprays & Specialised Liquids

## All-Round Sealing Spray

A versatile spray on seal that seals all kinds of small cracks, holes, pitting and more.

Fast, simple and easy to use, All-Round Sealing Spray can be painted, works with most materials and is highly weather-resistant.



## Anti-Spatter Spray

An industrial-grade welding protection spray that is very effective.

Anti-Spatter Spray stops welding spray from sticking to the welding nozzle or to surfaces around the target area. Once applied, it keeps you weld nozzle clean.



## Contact Spray

A quality spray for maintaining electrical connections and contacts.

Our Contact Spray dispels moisture and prevents current leakage. Used on all kinds of electrical devices, equipment, connections and components.



## Leak Detection Spray

The fast, easy and reliable way to find the smallest of leaks before they become big problems. Leak Detection Spray makes finding leaks on pipes, tanks, containers, hoses and fittings easy.



## Crack Testing Dye Penetrant Flaw Identification Kit

A fast, non-destructive and highly reliable way of testing metals, ceramics, plastics and other materials.

Our Crack Testing Dye Penetrant Flaw Identification Kit helps you find small cracks, flaws and faults before they cause big problems.



## Bike Care Set - 13 Piece Maintenance Kit

The Weicon bicycle care set consists of a variety of products that allow you to clean, lubricate and care for all types of bikes quickly and gently.

It includes cleaners, lubricants, adhesives and more.

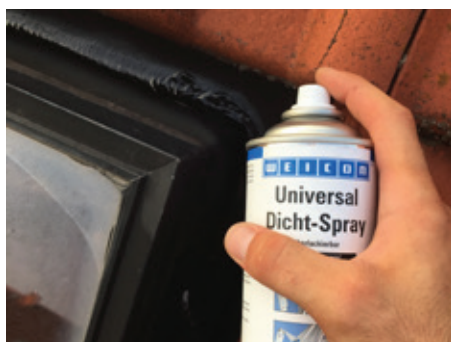

All-Round Sealing Spray



Contact Spray



Leak Detection

# Cable Lugs, Links & Terminals

## Cable Lugs

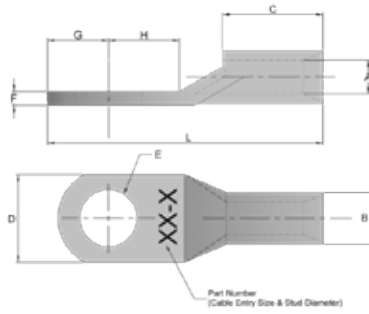

Produced from 99.9% seamless copper tube and tin plated after pressing.

Made to Australian & NZ Standards and suit Australian compression tools. Full dimensions for each available online so you can be sure you're getting the right size for your job.

| Standard Cable Entry Sizes |                   |                    |                    |
|----------------------------|-------------------|--------------------|--------------------|
| 1.5mm <sup>2</sup>         | 10mm <sup>2</sup> | 50mm <sup>2</sup>  | 150mm <sup>2</sup> |
| 2.5mm <sup>2</sup>         | 16mm <sup>2</sup> | 70mm <sup>2</sup>  | 185mm <sup>2</sup> |
| 4mm <sup>2</sup>           | 25mm <sup>2</sup> | 95mm <sup>2</sup>  | 240mm <sup>2</sup> |
| 6mm <sup>2</sup>           | 35mm <sup>2</sup> | 120mm <sup>2</sup> | 300mm <sup>2</sup> |

Each Available in a Range of Stud Hole Sizes.

## Cable Links



| Standard Cable Entry Sizes |                   |                   |                    |                    |                    |
|----------------------------|-------------------|-------------------|--------------------|--------------------|--------------------|
| 1.5mm <sup>2</sup>         | 6mm <sup>2</sup>  | 25mm <sup>2</sup> | 70mm <sup>2</sup>  | 150mm <sup>2</sup> | 300mm <sup>2</sup> |
| 2.5mm <sup>2</sup>         | 10mm <sup>2</sup> | 35mm <sup>2</sup> | 95mm <sup>2</sup>  | 185mm <sup>2</sup> | 400mm <sup>2</sup> |
| 4mm <sup>2</sup>           | 16mm <sup>2</sup> | 50mm <sup>2</sup> | 120mm <sup>2</sup> | 240mm <sup>2</sup> |                    |

Copper compression links for cables starting at 1.5mm<sup>2</sup> through to 400mm<sup>2</sup>. Manufactured from 99.9% copper tube, these links meet Australian & NZ standards and designed for use with Australian metric compression tools.

## Bootlace Pin Terminals - Single Conductor



| Standard Cable Entry Sizes |                    |                   |                    |
|----------------------------|--------------------|-------------------|--------------------|
| 0.25mm <sup>2</sup>        | 1mm <sup>2</sup>   | 6mm <sup>2</sup>  | 35mm <sup>2</sup>  |
| 0.34mm <sup>2</sup>        | 1.5mm <sup>2</sup> | 10mm <sup>2</sup> | 50mm <sup>2</sup>  |
| 0.5mm <sup>2</sup>         | 2.5mm <sup>2</sup> | 16mm <sup>2</sup> | 70mm <sup>2</sup>  |
| 0.75mm <sup>2</sup>        | 4mm <sup>2</sup>   | 25mm <sup>2</sup> | 300mm <sup>2</sup> |

Quality insulated ferrules available in a large range of sizes. Our Bootlace Pin Terminals for Single Conductors are made from tin plated copper with a Polyamide insulation sheath that is colour coded for conductors sizing.

## Nylon Cable Glands



|                        |                  |
|------------------------|------------------|
| Temperature Resistance | -40°C to +100°C  |
| Water Proof            | Yes, IP68        |
| UV Resistant           | Yes              |
| Flammability           | UL 94V2          |
| Metric Mounting        | Yes, 1.5mm Pitch |

| Cable Range  | Thread |
|--------------|--------|
| 3mm to 6.5mm | 12mm   |
| 5mm to 10mm  | 16mm   |
| 10mm to 14mm | 20mm   |
| 14mm to 18mm | 25mm   |
| 18mm to 25mm | 32mm   |
| 22mm to 32mm | 40mm   |
| 30mm to 38mm | 50mm   |
| 34mm to 44mm | 63mm   |

IP68 Rated Cable Glands made from quality Nylon with a silicone rubber washer included, our Nylon Cable Glands effectively seal against water, dirt and dust and have strong UV resistance.

## Elmotherm Air Dry Liquid Varnish



Drums of this high performance electrical varnish (aerosols also available).

This liquid version of Elmotherm 009-0008 combines excellent electrical properties, a high thermal rating and consistent, high performance.

| Sizes           |
|-----------------|
| 5L or 20L Drums |

| Colours |       |      |
|---------|-------|------|
| Black   | Clear | Grey |
| Red     | White |      |

## Epirez 324A Electrical Epoxy Compound



Something of an industry-standard, Epirez 324A is a high quality electrical epoxy used for a variety of repair and maintenance jobs.

It's easy to work with, has very high dielectric strength and sets hard for long lasting performance.

| Size    |
|---------|
| 2kg Kit |

## Epoxy Resin Putty



A very versatile form of kneadable epoxy putty that sets hard, bonds to most surfaces and materials and withstands 200°C.

This epoxy putty is used for everything from armature balancing to rebuilding damaged parts and components.

| Sizes            |
|------------------|
| 100g, 400g, 800g |

## Flit Plug Encapsulant Silicone - TSE 352



A high-quality silicone encapsulant for cables, electrical devices, potting of components and circuits and flit plug encapsulating.

This specialised component remains flexible, withstands 204°C and is approved to a number of Australian industrial standards.

| Size       |
|------------|
| 5.9kg Kits |

## Glyptal 1201 Red Enamel Spray



A high-performance enamel coating with excellent chemical, oil, abrasion, heat and moisture resistance.

Widely used for engine coating, anti-moisture and anti-corrosion coating, primer for iron and steel and as an internal coating for hydraulic tanks and bearing cases.

| Size  |
|-------|
| 361ml |

## Isolation Spray



Insulating spray with high dielectric strength for all kinds of connections, switches and components. Our Isolation Spray is crystal clear and creates a moisture and weatherproof barrier.

Isolation Spray has a high dielectric strength of 67.8 kV/mm. It exhibits good adhesion to most surfaces including metal, glass, plastic, wood and more.

| Size  |
|-------|
| 400ml |

## R391 Weatherproof Electrical Putty



A versatile, non-hardening insulating putty.

R391 Weatherproof Electrical Putty is widely used for insulating and sealing connections and does not crack, shrink or peel. This putty remains flexible yet creates a weatherproof seal and is very long lasting.

| Size      |
|-----------|
| 500gm Kit |

# Electrical Insulation Tapes & Shielding Tapes

## Adhesive Fibreglass Tape w/ Silicone Adhesive



|             |                        |
|-------------|------------------------|
| Temperature | +180°C                 |
| Adhesive    | Silicone Thermosetting |
| Backing     | Fibreglass Cloth       |

|                     |                       |
|---------------------|-----------------------|
| Total Thickness     | 0.18mm                |
| Roll Length         | 55 Metres             |
| Dielectric Strength | >2.5 kV<br>500V in 1s |

An adhesive backed insulation tape designed for high temperatures. Our Fibreglass Tape with Silicone Adhesive withstands 180°C, is very conformable and bonds well to most materials and surfaces.

| Standard Sizes |       |
|----------------|-------|
| 6mm            | 24mm  |
| 9mm            | 50mm  |
| 12mm           | 100mm |
| 15mm           | 150mm |
| 18mm           | 200mm |
| 21mm           |       |

## Adhesive Polyimide Tape



|             |                        |
|-------------|------------------------|
| Temperature | +200°C                 |
| Adhesive    | Silicone Thermosetting |
| Backing     | Polyimide Film         |

|                      |               |
|----------------------|---------------|
| Total Thickness      | 0.063mm       |
| Roll Length          | 33 Metres     |
| Dielectric Breakdown | 6kV (minimum) |

A high temperature tape made from thin Polyimide film coated with a silicone adhesive. Ideal for high temperature electrical insulation applications, high temperature masking and more.

| Standard Sizes |       |
|----------------|-------|
| 6mm            | 24mm  |
| 9mm            | 150mm |
| 12mm           | 200mm |
| 18mm           | 300mm |
| 21mm           |       |

## Adhesive Nomex Insulation Tape



|             |             |
|-------------|-------------|
| Temperature | 155°C       |
| Adhesive    | Acrylic     |
| Backing     | Nomex Paper |

|                      |                 |
|----------------------|-----------------|
| Total Thickness      | 0.145mm         |
| Roll Length          | 50 Metres       |
| Dielectric Breakdown | 2.5kV (minimum) |

A high voltage electrical insulation tape made from DuPont Nomex Paper with an acrylic adhesive. Nomex Adhesive Insulation Tape has good dielectric properties, is flame retardant and UI recognised.

| Standard Sizes |      |
|----------------|------|
| 6mm            | 21mm |
| 9mm            | 24mm |
| 12mm           | 36mm |
| 15mm           | 48mm |
| 18mm           |      |

## 3M 1181 Copper Foil EMI Shielding Tape



|          |                        |
|----------|------------------------|
| Backing  | Dead-Soft Copper       |
| Adhesive | Conductive Acrylic PSA |
| Copper   | 0.04mm Thick           |

|  |           |
|--|-----------|
| Total Thickness                        | 0.066mm   |
| Roll Length                            | 16.46Mtrs |
| Electrical Resistance through Adhesive | 0.005 ohm |

Designed for shielding electro magnetic interference. 3M 1181 Copper Foil Tape consists of a solid and highly conductive copper foil layer coated on one side with a special, conductive, adhesive.

| Standard Sizes |      |
|----------------|------|
| 6mm            | 21mm |
| 9mm            | 24mm |
| 12mm           | 36mm |
| 15mm           | 50mm |
| 18mm           |      |

## 3M Temflex 1610 PVC Tape

Thin, strong and highly conformable. 3M Temflex 1610 has a fast acting adhesive that works with most surfaces and can be smoothly wrapped around irregular objects. This tape is available by the roll in a selection of 5 colours.

| Roll Width |
|------------|
| 18mm       |



|                     |              |
|---------------------|--------------|
| Adhesive            | Rubber Based |
| Roll Length         | 20 Metres    |
| Dielectric Strength | >39.4 kV/mm  |
| Temperature         | 0°C to +80°C |



# Electrical Insulation Tapes & Shielding Tapes

## 3M Scotch 23 Rubber Splicing Electrical Tape



|             |                                 |
|-------------|---------------------------------|
| Temperature | 90°C Continuous                 |
| Elongation  | 1,000%                          |
| Backing     | Ethylene Propylene Rubber (EPR) |

|                     |           |
|---------------------|-----------|
| Total Thickness     | 0.76mm    |
| Roll Length         | 9 Metres  |
| Dielectric Strength | 31.5 mV/m |

| Roll Widths |
|-------------|
| 19mm        |
| 25mm        |

A high quality grade of rubber self-fusing tape, 3M Scotch 23 Electrical tape has excellent conformability and is easy to use. It is used in environments with continuous temperature up to 90°C and allows a large degree of stretch.

## Adhesive Polyester Film Tape, Clear



|             |                |
|-------------|----------------|
| Temperature | +130°C         |
| Adhesive    | Acrylic PSA    |
| Backing     | Polyester Film |

|                       |                  |
|-----------------------|------------------|
| Total Thickness       | 0.055mm          |
| Roll Length           | 66 Metres        |
| Insulation Resistance | 1x10 Ohm Minimum |

| Standard Sizes |      |       |
|----------------|------|-------|
| 6mm            | 21mm | 65mm  |
| 9mm            | 24mm | 75mm  |
| 12mm           | 32mm | 100mm |
| 15mm           | 40mm |       |
| 18mm           | 50mm |       |

A very thin, transparent adhesive tape. Our Adhesive Polyester Film Tape provides very good electrical insulation, has a high strength, pressure-sensitive acrylic adhesive.

## 3M Scotch Super 33+ Electrical Tape



|             |                          |
|-------------|--------------------------|
| Temperature | 105°C Continuous         |
| Elongation  | 250%                     |
| Backing     | Polyvinyl Chloride (PVC) |

|                     |             |
|---------------------|-------------|
| Total Thickness     | 0.177mm     |
| Roll Length         | 33 Metres   |
| Dielectric Strength | 1,150 V/mil |

| Roll Widths |
|-------------|
| 19mm        |
| 24mm        |

A premium grade PVC electrical tape that is tough, strong, long lasting and UV resistant. Black in colour and coated with an aggressive pressure-sensitive rubber based adhesive it creates water-tight seals with minimum bulk.

## 3M Scotchfil Electrical Insulation Putty



|             |             |
|-------------|-------------|
| Temperature | 0°C to 80°C |
| Elongation  | 1,000%      |
| Adhesive    | Self-Fusing |

|                     |            |
|---------------------|------------|
| Total Thickness     | 3.175mm    |
| Roll Length         | 1.5 Metres |
| Dielectric Strength | 575 V/mil  |

| Roll Width |
|------------|
| 38mm       |

A highly flexible, soft and pliable insulating putty in tape form. 3M Scotchfil Insulating Electrical Putty is non-corrosive, withstands 80°C, self-fusing and can be easily applied to irregular objects using just finger-pressure.

## Other Styles of Woven, Adhesive, Insulating & Conductive Electrical Tapes

The styles in this catalogue are only a small portion of the full range of electrical tapes we offer.

Whether you require Woven Insulation Tapes for Coils, High Voltage Mica Insulation, Specialised Adhesive Tapes or EMI Shielding Materials, our range has the application covered. For more information or assistance with grade selection please contact us.

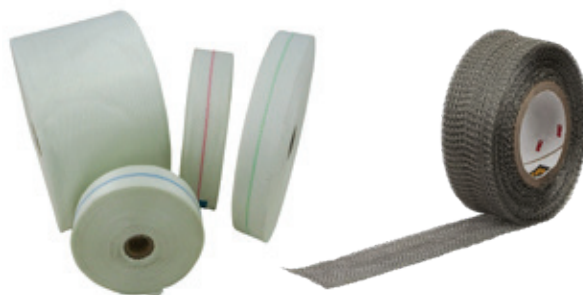

Vidatape C

3M Scotch Shielding

# Electrical Work Tools

## Automatic Wire Stripper No. 5

An automatic wire stripper that works with cables between 0.2mm<sup>2</sup> and 6mm<sup>2</sup>. Our No. 5 is fast, simple and easy to use.

Made in Germany from premium materials, this stripper can be adjusted to bare different lengths of conductor.



## Automatic Cable Stripper No. 7 Magic

A professional grade cable stripper with incredible versatility.

Automatically adjusting, our No. 7 Magic can be used with flexible, round cable between 0.5mm<sup>2</sup> and 16mm<sup>2</sup> cross section.



## Automatic Cable Stripper No. 7 F Magic

An Automatic Cable Stripper that adjusts to the size of the wire.

This professional quality stripping tool can be used with many types of multi-strand flat cables as well as numerous round cables and wires.



## Bootlace Crimper - 0.25mm to 2.5mm

Our small Bootlace Crimping Tool is a fast, reliable and easy to use crimper.

This tool is manufactured with cushioned handles and is compatible with all small size bootlace ferrules from 0.25mm<sup>2</sup> to 2.5mm<sup>2</sup>.



## Cable Scissors No. 35

Professional quality scissors for cutting, stripping and crimping a variety of cables.

Our No. 35 Scissors cut copper cables up to 35mm<sup>2</sup> and aluminium cables to 50mm<sup>2</sup>. Specially designed for heavy duty, industrial use with a range of features.



## Cable Stripper No. 4 - 28 H

An easy-to-use cable stripping knife that handles longitudinal and round stripping with ease.

Our Cable Stripper No. 4 – 28 H works with common round cables between 4mm and 28mm dia and features a hook knife for added versatility.



## Cable Stripper No. S 4 - 28 Multi

Used for stripping flexible cables between 4mm and 28mm diameter.

This versatile tool can strip around or along the cable and also includes an easy to use small cable and wire stripper in the handle for fast stripping of 0.5mm<sup>2</sup> to 6mm<sup>2</sup> cables.



S 4-28 Multi



No. 5 Stripper



7-F Stripper



No. 35 Workshop Scissors

## Cable Tie Fastening Tool

A simple and reliable way to quickly tension cable tie loops. Features 4 adjustable levels for quick tensioning and an all metal construction for lasting performance.

Suitable for Nylon ties between 2.2mm and 4.8mm wide.



## Data Cable Stripper No. 30

Fast and accurate stripping of many types of data cables.

Our No. 30 Data Cable Stripper is used on phone cables, control cables, data cables, bus lines and more. The stripping blade can be precision set and it works on round cables up to 10mm Ø.



## Duo Crimp Stripper No. 300

A very versatile tool that combines stripping, crimping and cutting into one.

Our Duo Crimp Stripper No. 300 has an automatic scanner for removing insulation and can be used with cables between 0.5mm<sup>2</sup> and 6mm<sup>2</sup> cross-section.



## Insulated Wire Stripper No. 6

An automatic cable and wire stripping tool that is fully insulated and tested for use with up to 1000 volts.

Our Insulated Wire Stripper No. 6 is used to strip cables and wires between 0.2mm<sup>2</sup> and 6mm<sup>2</sup>.



## Precision Wire Stripper S

An automatic wire stripper that works very well with small wires between 0.12mm and 0.8mm diameter.

This tool scans and adjusts to different conductor sizes, can strip different lengths and is fast, simple and easy to use.



## Tinned Cable Lug and Link Ratchet Crimping Tool

An economical solution for crimping tinned copper lugs and links between 1.5mm<sup>2</sup> and 16mm<sup>2</sup>.

This indent ratchet crimper is simple and easy to use.



## Universal Cable Stripper No 100

A universal style tool for stripping and dismantling cables. Our Universal Cable Stripper No 100 can be used for circular or longitudinal stripping and is self-adjusting to suit various sizes of cables.

It allows flush stripping to ceilings or walls.



Universal 100 Stripper



No. 30 Data Cable Stripper



Duo-Crimp No. 300



Precision Wire Stripper S

# Flexible Electrical Insulation Sheets & Materials

## DuPont Nomex 410 Electrical Insulation Paper



HV, Class C (220°C) Paper that has been trusted by industry for over 50 years.

Nomex 410 Insulation Paper offers exceptional electrical, thermal, chemical and mechanical properties. Specifications vary according to thickness.

Also available in pre-cut pieces and custom parts on request.

| Available Thicknesses |        |
|-----------------------|--------|
| 0.05mm                | 0.3mm  |
| 0.08mm                | 0.38mm |
| 0.13mm                | 0.51mm |
| 0.18mm                | 0.76mm |
| 0.25mm                |        |

| Roll Width, Per Metre |
|-----------------------|
| 914mm                 |

| Cut Sheets    |
|---------------|
| 250mm / 310mm |

## DMD Insulation Paper



An economical grade of flexible electrical insulation for use in medium voltage machines up to 155°C.

DMD is made from a combination of polyester film and fleece.

Specifications vary according to thickness and are detailed online.

| Available Thicknesses |        |
|-----------------------|--------|
| 0.15mm                | 0.30mm |
| 0.23mm                | 0.38mm |

| Roll Width, Per Metre |
|-----------------------|
| 1000mm                |

## Presspahn Transformer Insulation Paper



This electrical insulation sheet is strong, flexible and easy to work with.

Rated for use in applications up to 105°C.

Specifications vary according to thickness and are detailed online.

| Available Thicknesses |        |
|-----------------------|--------|
| 0.13mm                | 0.38mm |
| 0.25mm                | 0.50mm |

| Roll Width, Per Metre |
|-----------------------|
| 1000mm                |

## NMN Insulation Paper



A high quality, composite electrical insulation material consisting of Nomex and PET Film.

NMN Insulation Paper is tough, flexible and suitable for use in applications to 155°C.

| Available Thicknesses |        |
|-----------------------|--------|
| 0.15mm                | 0.42mm |
| 0.25mm                | 0.48mm |
| 0.37mm                |        |

| Roll Width, Per Metre |
|-----------------------|
| 900mm                 |

## Varnished Glass Cloth



Flexible, strong electrical insulation material made from woven fibreglass cloth coated with a polyester resin varnish.

Our Varnished Glass Cloth is a high quality grade suitable for use in up to Class H (180°C).

| Thickness | Roll Width, Per Metre |
|-----------|-----------------------|
| 0.25mm    | 914mm                 |

## Nylon Cable Ties



|                 |                |
|-----------------|----------------|
| Temperature     | -40°C to +85°C |
| Material        | Nylon 6/6      |
| Halogen Free    | Yes            |
| Flame Retardent | Yes, UL94V-2   |

| Available Sizes |               |
|-----------------|---------------|
| 100mm x 2.5mm   | 370mm x 4.8mm |
| 150mm x 3.6mm   | 370mm x 7.6mm |
| 200mm x 4.8mm   | 750mm x 8.8mm |
| 300mm x 4.8mm   |               |

Available in Packs of 100 Cable Ties.

Strong, reliable and easy to use. Our Nylon Cable Ties are available in a large range of sizes.

## Nylon UV Resistant Cable Ties



|                 |                     |
|-----------------|---------------------|
| Temperature     | -40°C to +85°C      |
| Material        | Ascend Vydyen 25WSP |
| Halogen Free    | Yes                 |
| Flame Retardent | Yes, UL94V-2        |

| Available Sizes |               |
|-----------------|---------------|
| 100mm x 2.5mm   | 370mm x 4.8mm |
| 150mm x 3.6mm   | 370mm x 7.6mm |
| 200mm x 4.8mm   | 550mm x 7.6mm |
| 300mm x 4.8mm   | 750mm x 8.8mm |

Available in Packs of 100 Cable Ties.

Strong and long lasting. These high quality cable ties are designed for the harsh Australian sun and have been tested to ensure 7+ years of durability. For fixing different size wires, pipes, poles, cables and lights.

## Stainless Steel Cable Ties - Natural 316



|             |                 |
|-------------|-----------------|
| Temperature | -60°C to +300°C |
| Material    | 316 SS          |
| UL Listed   | Yes, UL622275   |

| Available Sizes |                |
|-----------------|----------------|
| 125mm x 4.6mm   | 360mm x 7.9mm  |
| 200mm x 4.6mm   | 520mm x 7.9mm  |
| 360mm x 4.6mm   | 1000mm x 7.9mm |

Available in Packs of Either 10 or 100 Cable Ties.

Extremely high strength metal zip ties made from 316 Stainless Steel. These cable ties offer long term performance in high heat and other kinds of harsh environments where plastic ties are not suitable.

## Nylon Corrugated Conduit (No-Slit)



|                 |                    |
|-----------------|--------------------|
| Temperature     | -40°C to +120°C    |
| Material        | Nylon 6/6          |
| Halogen Free    | Yes                |
| Flame Retardent | Self-Extinguishing |

| Sleeving ID | Full Roll Length |
|-------------|------------------|
| 6.4mm       | 100 Metres       |
| 8.5mm       | 100 Metres       |
| 9.9mm       | 100 Metres       |

| Sleeving ID | Full Roll Length |
|-------------|------------------|
| 12.8mm      | 50 Metres        |
| 16.6mm      | 50 Metres        |
| 21.2mm      | 50 Metres        |

Made in Australia, this tubing has excellent chemical resistance, flexibility and durability. It is UV stabilised and self-extinguishing. Available in either 10Mtr packs or full rolls, this conduit has good physical properties and is easy to work with and install.

## Polypropylene Corrugated Tube | With or Without Slit



|             |                |
|-------------|----------------|
| Temperature | -20°C to +90°C |
| Material    | Polypropylene  |
| RoHS        | Compliant      |

| Standard Sleeving IDs |      |
|-----------------------|------|
| 7mm                   | 20mm |
| 10mm                  | 23mm |
| 13mm                  | 29mm |
| 16mm                  |      |

10Mtr Rolls

Our Polypropylene Corrugated Tube is flame retardant, UV stabilised, RoHS Compliant and available in a range of sizes.

# Heat Shrink & Electrical Sleeveings

## Thin, Single Wall Heat Shrink, 1200mm Long Lengths Available in Red, Black, Yellow or Green / Yellow Striped

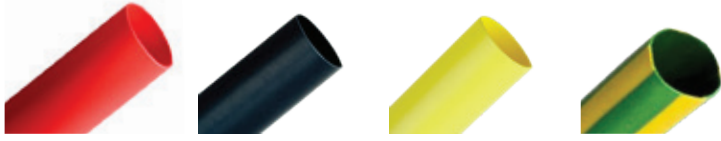

|                     |                 |
|---------------------|-----------------|
| Temperature         | -55°C to +125°C |
| Shrink Ratio        | 2 : 1           |
| Dielectric Strength | >20 kV/mm       |

|                |             |
|----------------|-------------|
| Flammability   | UL 2324-VW1 |
| Adhesive Lined | No          |

| Standard Diameters |       |
|--------------------|-------|
| 1.5mm              | 20mm  |
| 2.5mm              | 25mm  |
| 3.5mm              | 40mm  |
| 5mm                | 50mm  |
| 7mm                | 76mm  |
| 10mm               | 100mm |
| 13mm               |       |

Our Thin Wall Heat Shrink Tube has a 2:1 shrink ratio which means 20mm diameter sleeving will shrink down to just 10mm when heated.

It does not have any adhesive lining and is incredibly flexible and easy to handle. It is flame retarded and self-extinguishing. UV stabilised and rated to 600 volts.

## Thin, Single Wall Heat Shrink, Dispenser Packs Red, Black, Blue, Yellow, White, Clear or Green / Yellow Striped



| Diameter | Roll Length |
|----------|-------------|
| 1.5mm    | 20 Metres   |
| 2.5mm    | 20 Metres   |
| 3.5mm    | 20 Metres   |
| 5mm      | 10 Metres   |
| 7mm      | 10 Metres   |
| 10mm     | 10 Metres   |
| 13mm     | 5 Metres    |
| 20mm     | 5 Metres    |
| 25mm     | 5 Metres    |

Made from the same material as the 1200mm Long Lengths above, these dispenser packs are a convenient solution for medium users of heat shrink.

## Dual Wall, Adhesive Lined Heat Shrink



|                     |                 |
|---------------------|-----------------|
| Temperature         | -55°C to +125°C |
| Shrink Ratio        | 3 : 1           |
| Dielectric Strength | >15 kV/mm       |
| Elongation          | 300%            |

|                |                            |
|----------------|----------------------------|
| Flammability   | 3 (Outer Wall) (UL224 VW1) |
| Adhesive Lined | Yes                        |

| Standard Diameters |      |
|--------------------|------|
| 3mm                | 18mm |
| 4.8mm              | 24mm |
| 6mm                | 39mm |
| 9mm                | 52mm |
| 12mm               |      |

Glue lined heat shrink designed for waterproof sealing and insulating electrical connections. Supplied in full rolls (length depends on size) or 1200mm lengths, this heat shrink tube has a high shrink ratio (3:1), good mechanical properties and dielectric strength.

## Chemical Resistant Heat Shrink, Kits, Packs and Cut Lengths

Our range of Heat Shrink Sleeveing types, colours and sizes is large and continually growing. In addition to the styles listed here, we stock a variety of heat shrink kits, chemical resistant varieties as well as our Single Wall Heat Shrink in bulk rolls.

To browse this growing range, please visit the link included below or, for more information, do contact us.



# Heat Shrink & Electrical Sleeveings

## Heat Shrink End Caps

|                              |                                  |
|------------------------------|----------------------------------|
| Temperature Resistance       | -40°C to +100°C                  |
| Dielectric Strength          | >12 kV/mm                        |
| Tensile Strength             | 14 N/mm <sup>2</sup>             |
| Elongation at Break          | 350%                             |
| Heat Shock, 4 Hours at 200°C | No Dripping, Cracking or Flowing |

| Diameter | Shrink Diameter | Length | Diameter | Shrink Diameter | Length |
|----------|-----------------|--------|----------|-----------------|--------|
| 8mm      | 2mm             | 25mm   | 55mm     | 25mm            | 125mm  |
| 12mm     | 4mm             | 40mm   | 75mm     | 35mm            | 140mm  |
| 14mm     | 4mm             | 40mm   | 100mm    | 45mm            | 160mm  |
| 25mm     | 8mm             | 55mm   | 130mm    | 63mm            | 155mm  |
| 25mm     | 8mm             | 75mm   | 158mm    | 60mm            | 165mm  |
| 40mm     | 15mm            | 90mm   | 158mm    | 65mm            | 300mm  |



These easy to use caps are lined with a thick, hot-melt adhesive and have a high shrink ratio.

Ideal for insulating, sealing and protecting cable ends.

## Adhesive Heat Shrink Tape



|                     |           |
|---------------------|-----------|
| Dielectric Strength | 25kV / mm |
| Tensile Strength    | 12 MPa    |
| Elongation at Break | ≥350%     |

| Size                                  |
|---------------------------------------|
| 1mm Thick x 50mm Wide x 5 Metres Long |

| Colours     |
|-------------|
| Red & Green |

Quality electrical insulation tapes supplied with a layer of hot melt adhesive on one side. Our Adhesive Heat Shrink Tape is used for insulating busbars, repairing cable sheaths and sealing cable terminations and joints.

## Heat Shrink Cable Breakout Boots



|                        |                 |
|------------------------|-----------------|
| Temperature Resistance | -55°C to +110°C |
| Dielectric Strength    | >15 kV/mm       |
| Tensile Strength       | 13 MPA (min.)   |
| Elongation at Break    | 300%            |

| Main Diameter | # of Breakouts | Breakout Diameter |
|---------------|----------------|-------------------|
| 33mm          | 2              | 14mm              |
| 60mm          | 2              | 24mm              |
| 38mm          | 3              | 11mm              |
| 60mm          | 3              | 20mm              |
| 80mm          | 3              | 36mm              |
| 110mm         | 3              | 48mm              |
| 140mm         | 3              | 70mm              |

| Main Diameter | # of Breakouts | Breakout Diameter |
|---------------|----------------|-------------------|
| 40mm          | 4              | 12mm              |
| 55mm          | 4              | 20mm              |
| 75mm          | 4              | 25mm              |
| 82mm          | 4              | 30mm              |
| 92mm          | 4              | 35mm              |

Our Heat Shrink Cable Breakout Boots all possess good mechanical properties and seal against water and other environmental factors. They are UV stabilised and can be used with all kinds of cables up to 1kV.

Typically used for sealing, insulating and protecting splice points in cables.

## Wrap Around Heat Shrink Repair Sleeves



Quality, versatile heat shrink sleeving for insulating cable junctions and joints, repairing damage, protecting, sheathing and more. High shrink ratio and lined with a thick layer of hot melt adhesive for sealing. Very easy to use and apply.

| Diameter | Shrink Diameter |
|----------|-----------------|
| 50mm     | 10mm            |
| 75mm     | 22mm            |
| 100mm    | 30mm            |
| 140mm    | 38mm            |
| 190mm    | 55mm            |

1 Metre Lengths

# Heat Shrink & Electrical Sleeveings

## Expandable Polyester Braided Cable Sleeve



|             |                |
|-------------|----------------|
| Temperature | -50°C   +150°C |
| Short-Term  | +200°C         |
| Colour      | Black          |
| Base Fibre  | Polyester PBT  |

| Full Roll Sizes |        |             |        |
|-----------------|--------|-------------|--------|
| Size            | Length | Diameter    | Length |
| 1mm to 6mm      | 500M   | 14mm - 30mm | 50M    |
| 3mm to 9mm      | 200M   | 18mm - 35mm | 50M    |
| 5mm - 16mm      | 100M   | 20mm - 50mm | 25M    |
| 7mm - 19mm      | 100M   | 30mm - 55mm | 25M    |
| 8mm - 24mm      | 100M   | 35mm - 75mm | 25M    |
| 10mm - 27mm     | 100M   | 40mm - 80mm | 25M    |

An extremely flexible and easy to work with kind of braided electrical sleeving, our Expandable Polyester Braided Cable Sleeve is available in a large range of sizes.

Made from PBT Polyester for superior elasticity. Withstands -50°C to +150°C. Flame retarded and self-extinguishing to UL94 V0.

1mm & 3mm Also Available in 10Mtr Packs.  
All Others in 5Mtr Packs.

## Vidaflex 942 Sleeving - Available in Red, Black or Yellow



|                     |       |               |            |
|---------------------|-------|---------------|------------|
| Temperature         | 155°C | Outer Coating | Acrylic    |
| Electrical Strength | 2.5kV | Inner         | Fibreglass |

Vidaflex 942 Acrylic Fibreglass Electrical Sleeving is flexible insulating sleeving made from braided fibreglass that is coated in a solid layer of acrylic resin.

The resulting sleeving has a tough outer shell that resists abrasion and is available in a range of different colours to make lead and cable identification easy. Used for insulating and protecting all kinds of cables & wires.

| Full Roll Sizes |             |          |             |
|-----------------|-------------|----------|-------------|
| Diameter        | Roll Length | Diameter | Roll Length |
| 1mm             | 500 Metres  | 8mm      | 100 Metres  |
| 2mm             | 250 Metres  | 10mm     | 50 Metres   |
| 3mm             | 250 Metres  | 12mm     | 50 Metres   |
| 4mm             | 100 Metres  | 14mm     | 50 Metres   |
| 5mm             | 100 Metres  | 16mm     | 50 Metres   |
| 6mm             | 100 Metres  | 20mm     | 50 Metres   |
| 7mm             | 100 Metres  | 25mm     | 50 Metres   |

1mm to 6mm Dia also Available in 10Mtr Packs.

## Vidaflex SD550 Silicone Coated Sleeving



|                     |       |               |                 |
|---------------------|-------|---------------|-----------------|
| Temperature         | 155°C | Outer Coating | Silicone Rubber |
| Electrical Strength | 4kV   | Inner         | Fibreglass      |
| UL Rating           | 600V  |               |                 |

This high voltage, high temperature electrical insulation sleeving is made from fibreglass with a flexible silicone rubber outer layer. Used for insulating and protecting all kinds of cables & wires.

| Full Roll Sizes |             |          |             |
|-----------------|-------------|----------|-------------|
| Diameter        | Roll Length | Diameter | Roll Length |
| 1mm             | 250 Metres  | 10mm     | 100 Metres  |
| 2mm             | 250 Metres  | 12mm     | 100 Metres  |
| 3mm             | 250 Metres  | 14mm     | 50 Metres   |
| 4mm             | 250 Metres  | 16mm     | 50 Metres   |
| 5mm             | 250 Metres  | 20mm     | 50 Metres   |
| 6mm             | 250 Metres  | 25mm     | 50 Metres   |
| 8mm             | 200 Metres  |          |             |

1mm to 12mm Dia Available in 10Mtr Packs.  
14mm to 25mm Dia in 5Mtr Packs.



# Rigid Electrical Insulation Sheets & Materials

## Ultratrac H950 GPO3 Insulation Board

|  |                         |
|--|-------------------------|
| Temperature Resistance                                 | 160°C                   |
| Density  | 1,160 kg/m <sup>3</sup> |
| Flammability   | Class 94V-O             |
| Flexural Strength                                      | 25,000 PSI              |
| Compressive Strength                                   | 30,000 PSI              |
| Dielectric Strength, Parallel, Step-By-Step In Oil, KV | 55.0 KV                 |



| Available Thickness |        |        |
|---------------------|--------|--------|
| 2.4mm               | 8mm    | 19mm   |
| 3.2mm               | 9.5mm  | 25.4mm |
| 4.8mm               | 12.7mm | 38mm   |
| 6.4mm               | 15.9mm |        |

| Standard Sheets |                 |
|-----------------|-----------------|
| 300mm x 300mm   | 600mm x 600mm   |
| 1200mm x 1200mm | 1200mm x 2400mm |

Contact Us for Custom Sizes or Parts.

A strong, high voltage heat resistant laminate. Our H950 GPO3 Insulation Board is used for making all kinds of electrical insulation and mechanical components.

Withstands up to 160°C with good physical & electrical values.

## SwitchPanel Type X

|                                |                             |
|--------------------------------|-----------------------------|
| Electrical Resistance          | > 10 Megohms                |
| Impact Resistance              | ~1mm Indentation            |
| Moisture Resistance            | < 1%                        |
| Steam Resistance 10 h @ 200kPa | No Delamination             |
| <b>Wear Resistance</b>         |                             |
| 50 Cycles                      | 50% Surface pattern removed |
| 375 Cycles                     | Pattern and colour removed  |



| Standard Thickness |      |
|--------------------|------|
| 6mm                | 10mm |

| Standard Sheets    |                    |                     |
|--------------------|--------------------|---------------------|
| 300mm <sup>2</sup> | 600mm <sup>2</sup> | 1200mm <sup>2</sup> |

Designed for use as a switchboard panel material, this tough, rigid electrical insulation material that can be cut to suit your requirements.

This board is easy to clean, non-sparking, non-corrosive and good temperature stability. It is manufactured to meet Australian standard AS 1795 – 1983.

## Other Rigid Electrical Insulation Materials

Many of our materials appear under more than one category on our website.

This is especially true for some of our rigid electrical materials which also show up under plastics and, in some cases, heat insulation products.

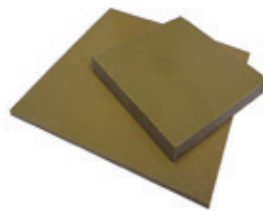

GPO1 High Temp. Insulation Board.  
Page 55



Silicone Bonded Mica  
Page 55



Epoxy Tubes & Rods  
Page 56

# Rigid Electrical Insulation Sheets & Materials

## Isoval 11 G11 Epoxy Fibreglass Sheet

Isoval 11 is a high quality, high performance grade of epoxy laminate used for all kinds of electrical insulation and mechanical support applications.

This material is manufactured from heat resistant epoxy resin which is used to laminate layer upon layer of fibreglass.

The result is a rigid, high strength sheet that can be cut or machined accurately and exhibits excellent electrical & thermal properties.

|  |                       |
|--|-----------------------|
| Temperature Resistance   | 180°C                 |
| Density  | 2.0 g/cm <sup>3</sup> |
| Flexural Strength 1,000 Hours at 100°C in Oil                      | 400 MPa               |
| Compressive Strength (Parrallel)                                   | 150 MPa               |
| Breakdown Voltage at 90°C in Oil Parallel to Laminations (IEC 243) | 40 KV                 |

| Available Thicknesses |       |       |      |      |       |
|-----------------------|-------|-------|------|------|-------|
| 0.2mm                 | 1mm   | 3mm   | 6mm  | 20mm | 38mm  |
| 0.3mm                 | 1.5mm | 3.5mm | 8mm  | 25mm | 50mm  |
| 0.5mm                 | 2mm   | 4.5mm | 10mm | 30mm | 65mm  |
| 0.8mm                 | 2.5mm | 5mm   | 16mm | 32mm | 100mm |

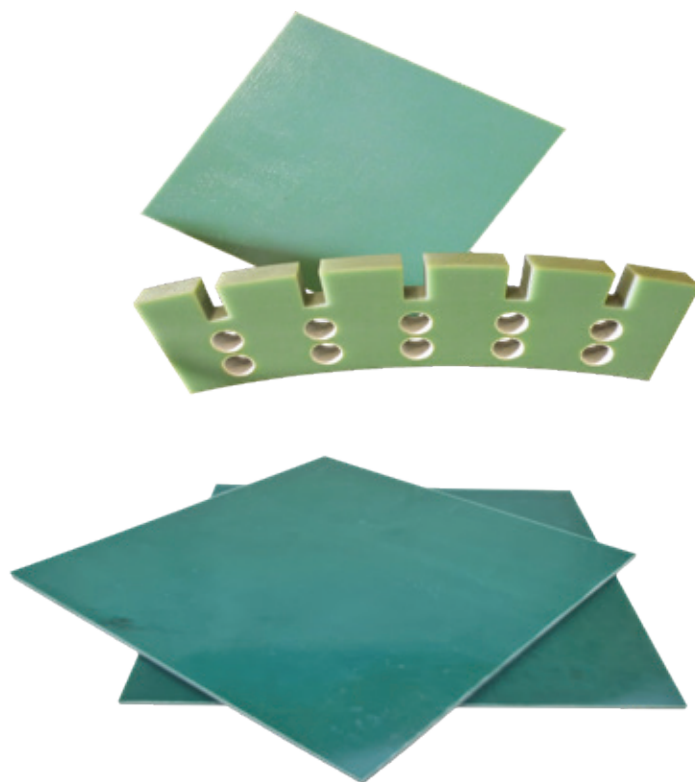

| Standard Sizes |                 |                |
|----------------|-----------------|----------------|
| 250mm Square   | 500mm Square    | 500mm x 1000mm |
| 1000mm Square  | 1040mm x 2140mm |                |

## Fabric Bakelite Sheet

|   |   |
|---|---|
| Temperature Resistance  | +125°C  |
| Colour  | Brown   |
| Impact Strength   | 24.5 KJ/m <sup>2</sup>  |
| Tensile Strength  | 63.8 MPa  |
| Electrical Breakdown Strength Perpendicular to Laminations In Transformer Oil at 90°C | 4kV/mm (0.5 to 1mm)<br>3kV/mm (1.1 to 2mm)<br>2kV/mm (2.1 to 3mm) |

| Standard Sizes |                 |                |
|----------------|-----------------|----------------|
| 250mm Square   | 500mm Square    | 500mm x 1000mm |
| 1000mm Square  | 1020mm x 2020mm |                |

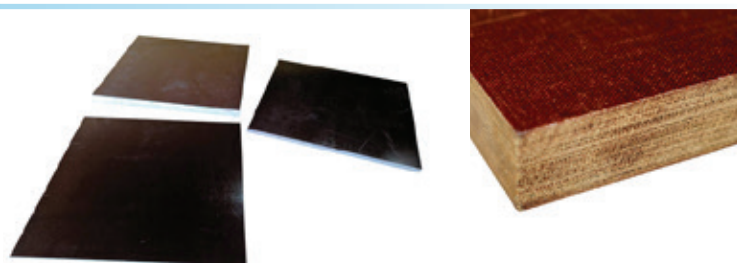

An economical grade of hard wearing plastic, Fabric Bakelite Sheet combines good electrical properties and excellent mechanical strength.

| Available Thicknesses |     |      |      |      |      |
|-----------------------|-----|------|------|------|------|
| 0.8mm                 | 3mm | 8mm  | 16mm | 28mm | 50mm |
| 1.5mm                 | 5mm | 10mm | 20mm | 32mm |      |
| 2.4mm                 | 6mm | 12mm | 25mm | 38mm |      |

## Fabric Bakelite Rod

| Standard Diameters |      |       |
|--------------------|------|-------|
| 10mm               | 22mm | 52mm  |
| 13mm               | 25mm | 80mm  |
| 16mm               | 32mm | 110mm |
| 20mm               | 40mm | 130mm |

| Standard Lengths |        |
|------------------|--------|
| 500mm            | 1000mm |

A tough, strong and durable form of rigid rod. Fabric reinforced Bakelite Rod combines excellent machinability and electrical insulation performance with an economic price.



## 316 Stainless Steel Shim

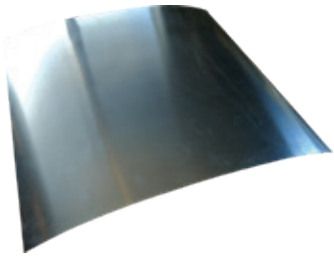

Grade 316 Stainless has excellent resistance to corrosion and good strength.

Often used for lining, sealing and spacing work in corrosion protection or sanitary applications.

| Available Thicknesses |        |        |
|-----------------------|--------|--------|
| 0.05mm                | 0.12mm | 0.25mm |
| 0.08mm                | 0.16mm | 0.40mm |
| 0.10mm                | 0.20mm | 0.50mm |

| Standard Sheet Sizes |                       |
|----------------------|-----------------------|
| 300mm Square         | Per Metre, 300mm Wide |

## Brass Shim

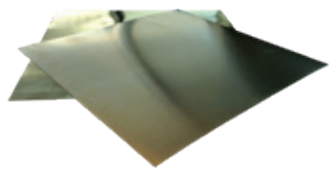

Half-Hard Brass Shim is available in either pre-cut pieces or by the metre.

With good corrosion and weathering resistance it's ideal for indoor or outdoor use and can be cut and worked as required.

| Available Thicknesses |        |        |        |
|-----------------------|--------|--------|--------|
| 0.05mm                | 0.12mm | 0.25mm | 0.50mm |
| 0.08mm                | 0.16mm | 0.30mm |        |
| 0.10mm                | 0.20mm | 0.40mm |        |

| Standard Sheet Sizes |                       |
|----------------------|-----------------------|
| 300mm Square         | Per Metre, 300mm Wide |

## Mild Steel Shim



Mild Steel Shim is a cost-effective and long lasting option for the production of spacers, washers, metallic gaskets, mounts and components.

Sometimes known as low carbon steel, our mild steel shim stock is cold rolled and easy to form and fabricate

| Available Thicknesses |        |        |        |
|-----------------------|--------|--------|--------|
| 0.05mm                | 0.12mm | 0.25mm | 0.50mm |
| 0.08mm                | 0.16mm | 0.30mm |        |
| 0.10mm                | 0.20mm | 0.40mm |        |

| Standard Sheet Sizes |                       |
|----------------------|-----------------------|
| 300mm Square         | Per Metre, 300mm Wide |

## A Grade Engineering Felt

|                       |                         |
|-----------------------|-------------------------|
| Temperature           | 93°C                    |
| Colour                | White / Off-White       |
| Composition           | ≥70% Wool               |
| Density               | 0.34 g/cm <sup>3</sup>  |
| Tensile Strength (MD) | 48 kp / cm <sup>2</sup> |
| Tensile Strength (TD) | 35 kp / cm <sup>2</sup> |



A strong, dense form of engineering felt. This grade can be cut to precise shapes and is very durable with high abrasion resistance.

Also available in a huge range of cut Felt Sealing Strips at [swiftsupplies.com.au/felt-sealing-strips/](http://swiftsupplies.com.au/felt-sealing-strips/)

| Available Thicknesses |       |        |        |
|-----------------------|-------|--------|--------|
| 1.6mm                 | 6.4mm | 12.7mm | 25.4mm |
| 3.2mm                 | 8mm   | 16mm   |        |
| 4.8mm                 | 9.5mm | 19mm   |        |

| Standard Sizes |              |                        |
|----------------|--------------|------------------------|
| A Grade        | 500mm Square | Per Metre, 1500mm Wide |
| B Grade        | 500mm Square | Per Metre, 1820mm Wide |

## B Grade Industrial Felt

|             |                        |
|-------------|------------------------|
| Temperature | 93°C                   |
| Colour      | White / Off-White      |
| Composition | ≥55% Wool              |
| Density     | 0.18 g/cm <sup>3</sup> |

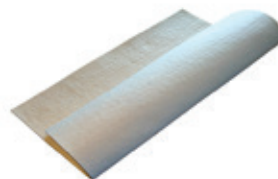

B Grade Felt is a lower density alternative to our A Grade Industrial Felt. Compared to this other grade, B Grade is also more economical and still offers excellent durability, wear resistance and a long service life.

| A Grade Felt Strips |                 |
|---------------------|-----------------|
| Thicknesses         | 1.6mm to 25.4mm |
| Standard Widths     | 5mm to 100mm    |
| Standard Length     | 1500mm          |

Not All Thicknesses Available in All Widths. Please Contact Us for Custom Sizes.

# Cork Sealing Materials

## Industrial Cork Sheet (SBR Rubber Bonded) MR31



|              |                                |
|--------------|--------------------------------|
| Temperature  | -30°C to +110°C                |
| Binder       | SBR (Styrene Butadiene Rubber) |
| Hardness     | 60 Shore A (±5)                |
| Density      | 650 kg/m <sup>3</sup>          |
| Stress Range | 1.5 to 6 mPa                   |

| Standard Sizes |                |                 |
|----------------|----------------|-----------------|
| 250mm x 310mm  | 510mm x 1270mm | 1040mm x 1270mm |

| Available Thicknesses |       |     |
|-----------------------|-------|-----|
| 1.5mm                 | 2mm   | 3mm |
| 4.8mm                 | 6.4mm |     |

A compressible, flexible and highly effective cork used for sealing and gaskets. Manufactured with an SBR binder, this grade is economical and very good at sealing oils in applications with low to medium bolt loads.

## Premium Cork Sheet (Nitrile Bonded) ACN60



|                 |                                |
|-----------------|--------------------------------|
| Temperature     | -30°C to +125°C                |
| Binder          | NBR (Nitrile Butadiene Rubber) |
| Hardness        | 75 Shore A (±5)                |
| Compressibility | 20% - 30%                      |
| Density         | 950 kg/m <sup>3</sup>          |
| Stress Range    | 5.5 to 20 mPa                  |

| Standard Sizes |                |                 |
|----------------|----------------|-----------------|
| 250mm x 310mm  | 510mm x 1270mm | 1040mm x 1270mm |

| Available Thicknesses |       |     |
|-----------------------|-------|-----|
| 1.5mm                 | 2mm   | 3mm |
| 4.8mm                 | 6.4mm | 8mm |
| 9.5mm                 |       |     |

A tough, strong and long lasting form of rubberised cork.

This grade has controlled cork granules, a nitrile rubber binder and wider temperature resistance. It seals fuels and oils and is ideal for making gaskets. This electrical grade cork is also often used for sealing transformers.

## Transformer Grade, High Rubber Content Cork Sheet

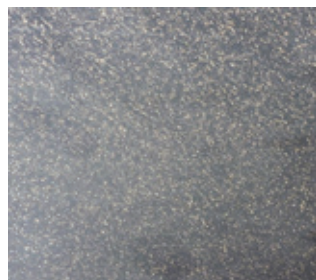

|              |                                |
|--------------|--------------------------------|
| Temperature  | -30°C to +125°C                |
| Binder       | NBR (Nitrile Butadiene Rubber) |
| Hardness     | 70 Shore A (±5)                |
| Density      | 1,100 kg/m <sup>3</sup>        |
| Stress Range | 3.0 to 20 mPa                  |
| Elongation   | 100%                           |

| Standard Size |
|---------------|
| 915mm Square  |

| Available Thicknesses |       |       |
|-----------------------|-------|-------|
| 1.5mm                 | 4.8mm | 9.5mm |
| 3mm                   | 6.4mm |       |

A specialised type of cork sheet with a very high percentage of Nitrile rubber. TD1150 is widely used for making cork transformer gaskets and seals, electrical bushings and more.

## Premium Grade Cork Sheet (Neoprene Bonded) NP50



|                 |                            |
|-----------------|----------------------------|
| Temperature     | -30°C to +120°C            |
| Binder          | Neoprene / Polychloroprene |
| Hardness        | 70 Shore A (±5)            |
| Density         | 825 kg/m <sup>3</sup>      |
| Compressibility | 25% - 35%                  |

| Standard Sizes |                |                 |
|----------------|----------------|-----------------|
| 250mm x 310mm  | 510mm x 1270mm | 1040mm x 1270mm |

| Available Thicknesses |     |       |
|-----------------------|-----|-------|
| 1.5mm                 | 3mm | 4.8mm |
| 6.4mm                 | 8mm | 9.5mm |

A high quality, industrial grade cork sheet made with a Neoprene rubber binder. NP50 Electrical Grade Neoprene Cork Sheet is compatible with oil, fuels and many other fluids and is ideal for making all kinds of seals and gaskets.

## Sealon Adhesive PTFE Instant Gasket Tape



| Available Sizes |              |
|-----------------|--------------|
| 3mm x 30Mtrs    | 14mm x 5Mtrs |
| 5mm x 20Mtrs    | 17mm x 5Mtrs |
| 7mm x 15Mtrs    | 20mm x 5Mtrs |
| 10mm x 8Mtrs    | 25mm x 5Mtrs |

|                         |                          |
|-------------------------|--------------------------|
| Temperature Resistance  | -232°C to +315°C         |
| Colour                  | White                    |
| Chemical Compatability  | 0-14pH                   |
| Matrix Tensile Strength | ≤ 6,800 PSI              |
| Pressure Range          | Full Vacuum to 3,000 PSI |
| Approvals               | FDA, DVGW, BAM & TUV     |

A high-performance gasket tape made from pure, expanded PTFE.

Sealon is ideal for making instant gaskets for all kinds of flanges, has great temperature resistance, very good chemical resistance and is fast, simple and easy to use.

## Pipe Repair Kits

| Available Sizes |
|-----------------|
| 5cm x 1.5Mtrs   |
| 5cm x 3.5Mtrs   |
| 10cm x 3.5Mtrs  |



Fast, simple and permanent. Our Pipe Repair Kits work with almost all types of pipe work and are designed to fix leaks without the need for special tools.

## Grey Silicone Self-Fusing Sealing and Insulating Tape



A versatile tape that can be used for everything from sealing pipes and hoses to general waterproofing and electrical cable splicing.

| Size                 |
|----------------------|
| 25mm Wide x 3 Metres |

This rubber sticks to itself well and is available in convenient, 3 metre long rolls. Withstands up to 230°C and has good stretch (450% max.) characteristics for easy installation.

## PTFE Thread Seal Tapes

We stock thread seal tapes in two different types: Standard and Gas.

Both of these tapes are used to seal all kinds of threaded hose, pipe and fitting connections and handle a range of temperatures.

Our PTFE Gas Thread Seal Tape is suitable for use with natural gas, propane, butane, methane and more.



| Standard         |
|------------------|
| 12mm X 10 Metres |
| White            |



| Gas              |
|------------------|
| 12mm X 10 Metres |
| Yellow or Pink   |

## PTFE Thread Sealing Cord DF175

| Size        |
|-------------|
| 175Mtr Roll |

The easy way to seal threaded connections and permanently prevent leaks. Weicon Thread Sealing Cord is made from pure PTFE and eliminates the risk of tearing and separation of PTFE and carrier so often found with conventional Thread Sealing Tapes.



# Gasket Tools

## AllPax Gasket Cutter System - Heavy Duty - 0.25" to 61"

Professional-Grade Gasket Cutter Systems used for cutting cork, rubber, felt, sponge, compressed fibre and more.

Our Heavy-Duty Gasket Cutter Kits are engineered for simple, fast and accurate cutting and are very long lasting.



## AllPax Gasket Cutter System - Medium Duty - 1" to 49"

Made in the USA, easy to use and very long lasting.

Our Medium Duty Allpax Gasket Cutter Systems are used for cutting ring and circular gaskets up to 1200mm OD from rubber, fibre, felt, sponge, cork and more.



## AllPax Gasket Cutter System - Light Duty - 0.25" to 6"

Our Light Duty Allpax Gasket Cutter Systems are used for cutting ring and circular gaskets and washers up to 152mm OD

The Work well with rubber, fibre, felt, sponge, cork and more. Made in the USA, easy to use and very long lasting.



## Allpax Hollow Hole Punch Sets - 16 Piece Kit

Heavy-duty hollow punches for creating holes in a range of materials like rubber, leather and cork.

This 16 Piece Hole Punching Kit contains the heavy duty handle and 15 different hole punches that range from 3.175mm (1/8") to 30.1mm (1 & 3/16").



## Allpax Hollow Hole Punch Sets - 27 Piece Kit

An expanded version of our 16 piece kits made from the same quality materials.

This 27 Piece Hole Punching Kit contains the heavy duty handle and 26 different hole punches that range from 3.175mm (1/8") to 50.8mm (2") as well as a mandrel.



## Dovetail Punch Kit - AX1855

Made in the USA, easy to use and very long lasting. This 3 Piece kit is made from high strength steel and requires no pre-measuring.

Our Dovetail Punch Kit is used for making interlocking joins on larger flange gaskets, cork, sponge and rubber sealing strips.



## FlangeKing Gasket Removal & Changing Tool

A professional-grade tool designed to help workers quickly and safely remove old gaskets and install new ones.

The FlangeKing has been engineered from quality materials for long lasting performance and ease of use.



## AllPax Dead Blow Hammers

Ideal for use with hollow punch tools. Our Dead Blow Hammers have a steel core, soft plastic exterior and textured handle for superior comfort.

They have no exposed metal, are durable and long lasting.



# Gland Packing for Pumps & Valves

## GFO Packing Style 8000T



Premium Packing that is made from 100% Gore GFO Fibre.

This packing combines the benefits of Graphite & Teflon to offer excellent pressure, heat and chemical resistance with long lasting performance.

## Graphite Packing Style 3000G (Acrylic Yarn)



General purpose style of packing made in the USA.

This type is used for pump and valve sealing and combines long lasting acrylic fibres with the low friction performance of graphite.

## Graphite Packing Style 5000 (100% Graphite)



Made from high purity graphite yarns, our Style 5000 Packing is self-lubricating, low friction and able to handle elevated temperatures (up to 649°C in steam).

It offers very good sealing properties.

## PTFE Packing Style 3000T (Acrylic Yarn)



A general purpose type of gland packing able to be used to seal in pumps and valves.

Inerlock braided ffrom acrylic with a PTFE lubricant it is tough, long lasting and low friction.

## PTFE Packing Style 344 (100% PTFE)



High-performance, industrial grade gland packing.

344 is made from 100% pure PTFE Filaments to ensure excellent chemical resistance, very low friction and extremely long-lasting performance.

| Standard Sizes     |                    |                     |                   |                   |
|--------------------|--------------------|---------------------|-------------------|-------------------|
| 3.2mm <sup>2</sup> | 6.4mm <sup>2</sup> | 9.5mm <sup>2</sup>  | 16mm <sup>2</sup> | 22mm <sup>2</sup> |
| 4.8mm <sup>2</sup> | 8mm <sup>2</sup>   | 12.7mm <sup>2</sup> | 19mm <sup>2</sup> | 25mm <sup>2</sup> |

All Available by the Metre.

|                | 8000T                          | 3000G               | 5000                           | 3000T           | 344               |
|----------------|--------------------------------|---------------------|--------------------------------|-----------------|-------------------|
| Base Fibre     | 100% GFO                       | Acrylic w/ Graphite | 100% Graphite                  | Acrylic w/ PTFE | 100% PTFE         |
| Construction   | Interlock Braid                | Interlock Braid     | Plait Braid                    | Interlock Braid | Interlock Braid   |
| pH Range       | 0-14 <sup>1</sup>              | 4-10                | 0-14 <sup>1</sup>              | 2-12            | 0-14 <sup>1</sup> |
| Shaft Speed    | 21MPs                          | 5.1MPs              | 20MPs                          | 11.2MPs         | 5.1MPs            |
| Pressure       | 20 BAR Pumps<br>138 BAR Valves | 20.7 BAR            | 34 BAR Pumps<br>207 BAR Valves | 34.5 BAR        | 20.6 BAR Pumps    |
| Temperature    | 260°C                          | 260°C (In Air)      | 455°C (In Air)                 | 260°C           | 260°C             |
| Services Areas | Pumps & Valves                 |                     |                                |                 |                   |

<sup>1</sup>Except Strong Oxidisers

## Sure-Cut Packing Cutters



Heavy duty scissors designed for cutting gland packing.

These industrial packing scissors can cut through 25mm<sup>2</sup> packing for 90° butt joins or 16mm<sup>2</sup> for 45° skive joins.

Ideal for anyone making packing rings on a repeated basis.

# Rubber Sheet & Mats

## Natural Rubber Insertion Sheet, Black 60 Duro



|             |             |
|-------------|-------------|
| Temperature | 0°C to 70°C |
| Elongation  | 300%        |

|               |           |
|---------------|-----------|
| Tear Strength | 12 N / mm |
| Potable Water | No        |

Tough, abrasion resistant and long lasting. Natural rubber insertion sheet is an economical grade of general purpose rubber suitable for many day-to-day sealing and lining applications.

| Standard Thicknesses |      |
|----------------------|------|
| 1.5mm                | 6mm  |
| 3mm                  | 9mm  |
| 4.5mm                | 12mm |

## Neoprene Rubber Sheet, Black 60 Duro

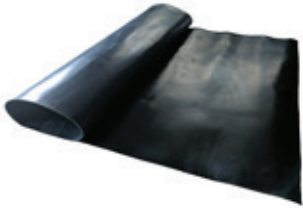

|             |                |
|-------------|----------------|
| Temperature | -20°C to 100°C |
| Elongation  | 300%           |

|               |           |
|---------------|-----------|
| Tear Strength | 12 N / mm |
| Potable Water | No        |

An economical, general-purpose grade of rubber sheet. Neoprene has good oil compatibility and UV resistance. It is widely used for sealing strips, gaskets, lining and more.

| Standard Thicknesses |      |
|----------------------|------|
| 0.8mm                | 8mm  |
| 1.5mm                | 9mm  |
| 3mm                  | 12mm |
| 4.5mm                | 16mm |
| 6mm                  | 19mm |

## Nitrile Rubber Sheet, Black 60 Duro

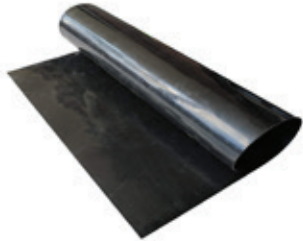

|             |                |
|-------------|----------------|
| Temperature | -25°C to +90°C |
| Elongation  | 400%           |

|               |           |
|---------------|-----------|
| Tear Strength | 40 N / mm |
| Potable Water | No        |

This rubber has excellent resistance to fuels and oils and is commonly used for making automotive gaskets and seals as well as gaskets for the marine sectors and seals for tanks and pipelines.

| Standard Thicknesses |       |
|----------------------|-------|
| 0.8mm                | 4.5mm |
| 1.5mm                | 6mm   |
| 3mm                  | 9mm   |

## Nitrile Rubber Sheet, White 55 Duro, FDA Approved

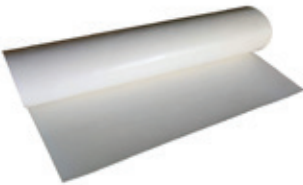

|             |                |
|-------------|----------------|
| Temperature | -25°C to +90°C |
| Elongation  | 350%           |

|               |           |
|---------------|-----------|
| Tear Strength | 15 N / mm |
| Potable Water | Yes       |

Our Nitrile Rubber Sheet (White, FDA Compliant) is non-marking, non-toxic and non-allergenic. Used for all kinds of lining, sealing and protecting applications (especially in the food & beverage sectors).

| Standard Thicknesses |       |
|----------------------|-------|
| 0.8mm                | 4.5mm |
| 1.5mm                | 6mm   |
| 3mm                  | 9mm   |

## EPDM Rubber Sheet, Black 60 Duro



|             |                 |
|-------------|-----------------|
| Temperature | -30°C to +120°C |
| Elongation  | 400%            |

|               |           |
|---------------|-----------|
| Tear Strength | 45 N / mm |
| Potable Water | No        |

This rubber has excellent resistance to fuels and oils and is commonly used for making automotive gaskets and seals as well as gaskets for the marine sectors and seals for tanks and pipelines.

| Standard Thicknesses |       |
|----------------------|-------|
| 1mm                  | 4.5mm |
| 1.5mm                | 6mm   |
| 2mm                  | 9mm   |
| 3mm                  | 12mm  |

## EPDM Rubber for Potable Water (Black, 65 Duro)



|             |                 |
|-------------|-----------------|
| Temperature | -30°C to +120°C |
| Elongation  | 350%            |

|                               |     |
|-------------------------------|-----|
| Potable Water                 | Yes |
| AS / NZS 4020 & WAS Approved. |     |

A premium grade EPDM rubber designed specifically for making gaskets, seals and linings for drinking water applications.

| Standard Thicknesses |       |
|----------------------|-------|
| 1.5mm                | 4.5mm |
| 3mm                  |       |



## Silicone Rubber, Red 60 Duro



| Standard Sizes         |  |
|------------------------|--|
| Per Metre, 1200mm Wide |  |
| 600mm Square Mats      |  |

| Standard Thicknesses |       |
|----------------------|-------|
| 0.8mm                | 3mm   |
| 1.6mm                | 4.8mm |
| 2mm                  | 6.4mm |

## Silicone Rubber White, Red 60 Duro

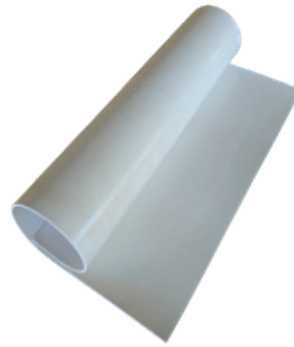

| Standard Sizes         |  |
|------------------------|--|
| Per Metre, 1200mm Wide |  |
| 600mm Square Mats      |  |
| 600mm x 1200mm Mats    |  |

| Standard Thicknesses |       |
|----------------------|-------|
| 1.5mm                | 4.8mm |
| 3mm                  |       |

## Silicone Rubber, Black 60 Duro



| Standard Sizes         |  |
|------------------------|--|
| Per Metre, 1200mm Wide |  |
| 600mm Square Mats      |  |
| 300mm x 1200mm Mats    |  |

| Standard Thicknesses |     |
|----------------------|-----|
| 1mm                  | 3mm |
| 1.5mm                | 5mm |
| 2mm                  | 6mm |

## Silicone Rubber, Translucent 40 Duro

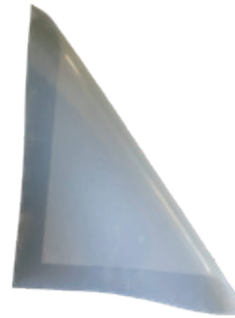

| Standard Sizes         |  |
|------------------------|--|
| Per Metre, 1200mm Wide |  |

| Standard Thicknesses |     |
|----------------------|-----|
| 1mm                  | 6mm |
| 3.2mm                | 8mm |

Our range of Silicone Rubber Gasket Sheets is available to browse online and includes a large range of sheet sizes, colours and thicknesses.

These premium grade rubbers are all FDA Compliant (FDA 21 CFR) and have excellent resistance to heat. Used for a whole range of applications, they are among our best selling types of rubber.

All are industrial grade silicone and all provide excellent sealing properties over a wide temperature range (-60°C to +250°C). They also have good UV and ozone resistance and are easy to cut and handle.

## Silicone Gaskets, Washers, Strip and Custom Components

In addition to the large range of silicone sheets, we are also pleased to offer a full fabrication service.

We can supply silicone gaskets, washers, strips, seals and more to suit your specifications.

Some of the more common standard size silicone gaskets are also available online (cut from our Red Silicone Rubber).

For custom sizes or other shapes, please do contact us.

| Continuous Operating Temperature | -60°C to +230°C |
|----------------------------------|-----------------|
| Short-Term Operating Temperature | 250°C           |
| Brittle Point                    | -80°C           |
| Tear Strength                    |                 |
| 60 Duro                          | 14.2 N / mm     |
| 40 Duro                          | 23 N/mm         |

- WRAS Approved for Potable Water at Temperatures up to 85°C
- FDA Compliant As Per 21 CFR 177.2600 (Suitable for Direct Food Contact)
- Compliant with EC 1935/2004 (Suitable for Direct Food Contact)
- RoHS and REACH Compliant
- FMVSS 302 Meets Part 571 Flammability Test



# Rubber Sheet & Mats

## Chutex Lining Rubber, Red 40 Duro

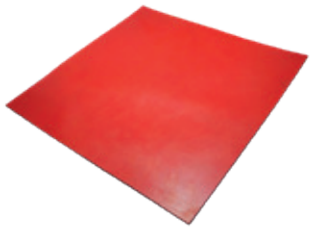

|             |               |
|-------------|---------------|
| Temperature | -20°C to 70°C |
| Elongation  | 550%          |

|                  |                        |
|------------------|------------------------|
| Tear Strength    | 60 N / mm              |
| Specific Gravity | 1.05 g/cm <sup>3</sup> |

A special type of rubber with outstanding resistance to abrasion, wearing and tearing. Chutex Red Lining Rubber is used for rubber skirts, wear protection and heavy-duty lining applications.

| Standard Thicknesses |      |
|----------------------|------|
| 1.5mm                | 9mm  |
| 3mm                  | 12mm |
| 4.5mm                | 19mm |
| 6mm                  |      |

## FRAS (Fire Resistant, Anti-Static) Rubber, Black 65 Duro

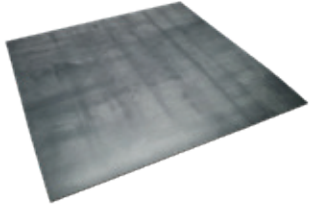

|             |               |
|-------------|---------------|
| Temperature | -25°C to 90°C |
| Elongation  | 300%          |

|                  |                        |
|------------------|------------------------|
| Tear Strength    | 60 N / mm              |
| Specific Gravity | 1.28 g/cm <sup>3</sup> |

Stocked in a range of thicknesses, our Fire Resistant and Anti-Static Rubber Sheet used in demanding, critical applications. Our FRAS Rubber is available by the metre or in custom cut parts.

| Standard Thicknesses |      |
|----------------------|------|
| 3mm                  | 12mm |
| 6mm                  | 16mm |
| 9mm                  | 19mm |

## Viton Rubber, Black, 70 Duro



|                  |                        |
|------------------|------------------------|
| Temperature      | -17°C to +200°C        |
| Elongation       | 250%                   |
| Tensile Strength | 7.14 mPa               |
| Specific Gravity | 1.92 g/cm <sup>3</sup> |

Our Viton Rubber Sheet is made with 100% Viton polymers in the USA.

This rubber is black, has a hardness of 70 duro and offers the best resistance to hydrocarbons, acids and alkalis of any rubber.

| Standard Sizes         |
|------------------------|
| Per Metre, 1200mm Wide |
| 300mm x 1200mm Mats    |
| 600mm x 1200mm Mats    |

| Standard Thicknesses |     |
|----------------------|-----|
| 1mm                  | 3mm |
| 1.5mm                | 5mm |
| 2mm                  | 6mm |

## Big Rib Rubber (Black)

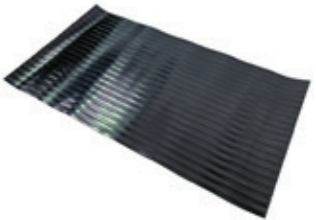

Anti-slip, hard wearing and very long lasting. This black rubber is easy to clean and used for all kinds of lining, protection and non-slip work.

Available by the metre or in standard cut sizes we can also supply this rubber cut to suit your requirements.

| Standard Sizes         |
|------------------------|
| Per Metre, 2000mm Wide |
| 450mm x 600mm Mats     |
| 600mm Square Mats      |

| Standard Thicknesses |     |
|----------------------|-----|
| 3.5mm                | 5mm |

## Blue Fluted Ribbed Rubber, Narrow

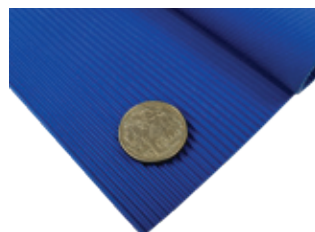
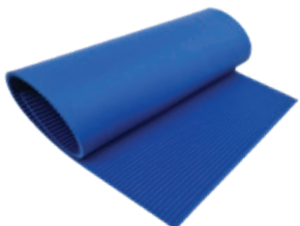

|                         |
|-------------------------|
| 3mm Thick x 1200mm Wide |
| Sold By the Metre       |

A versatile and highly visible rubber mat with good anti-slip performance. Our Blue Fluted Rubber has a narrow, closely-spaced triangular rib profile and a textured reverse-side for better adhesion and surface grip.

## Natural Rubber Insertion Strip, Black 60 Duro



Highly economical, non-adhesive rubber strips available by the lineal metre.

Natural Rubber Insertion Strips have good tensile strength, abrasion resistance and wear resistance.

|                             |              |
|-----------------------------|--------------|
| Temperature Resistance      | 0°C to +70°C |
| Colour                      | Black        |
| Elongation at Break         | 300%         |
| Max. Continuous Roll Length | 10 Metres    |
| Tensile Strength            | 7 MPa (min)  |

## Neoprene Rubber Strip, Black 60 Duro



Neoprene Rubber Strip is an easy and economical option for sealing around and between objects such as tanks, sheds, gutters, roofing and more.

Neoprene has good UV resistance and compatibility with oils.

|                             |                 |
|-----------------------------|-----------------|
| Temperature Resistance      | -20°C to +100°C |
| Colour                      | Black           |
| Elongation at Break         | 300%            |
| Max. Continuous Roll Length | 10 Metres       |
| Tensile Strength            | 5.9 MPa (min)   |

## EPDM Rubber Strip, Black 60 Duro



This rubber has excellent UV and Sunlight Resistance, good chemical resistance and a wide range of applications and uses.

Common applications include lining, sealing and weatherproofing.

|                             |                 |
|-----------------------------|-----------------|
| Temperature Resistance      | -30°C to +120°C |
| Colour                      | Black           |
| Elongation at Break         | 400%            |
| Max. Continuous Roll Length | 10 Metres       |
| Tensile Strength            | 11 MPa (min)    |

| Standard Thicknesses |                  |                 |             |
|----------------------|------------------|-----------------|-------------|
|                      | Insertion Rubber | Neoprene Rubber | EPDM Rubber |
| 1mm                  |                  |                 | ✓           |
| 1.5mm                | ✓                | ✓               | ✓           |
| 2mm                  |                  |                 | ✓           |
| 3mm                  | ✓                | ✓               | ✓           |
| 4.5mm                | ✓                | ✓               | ✓           |
| 6mm                  | ✓                | ✓               | ✓           |

| Standard Widths |       |       |
|-----------------|-------|-------|
| 25mm            | 100mm | 350mm |
| 35mm            | 150mm | 400mm |
| 40mm            | 200mm | 450mm |
| 50mm            | 250mm | 500mm |
| 75mm            | 300mm | 600mm |

All Available by the Metre.

Contact us for Custom Width, Other Thicknesses or Types of Rubber Strip.

## Glues and Adhesives for Rubber Strip

We are pleased to stock a number of glues suitable for fixing these rubber strips to all kinds of materials. Solutions like our GMK Rubber Metal Adhesive and Spray Adhesives are often selected for standard bonding of the Neoprene or NRI.

EPDM can be a little trickier and often requires something like our GMK 2510. For assistance with selection, don't hesitate to contact us.



# Rubber O Ring Cord

## Nitrile O Ring Cord, Black 70 Duro



|                        |                |
|------------------------|----------------|
| Temperature Resistance | -20°C to +90°C |
| Colour                 | Black          |
| Polymer                | NBR            |
| Hardness               | 70 Shore A     |

| Standard Sizes |       |         |          |
|----------------|-------|---------|----------|
| 1.6mm Ø        | 5mm Ø | 9.5mm Ø | 15mm Ø   |
| 2mm Ø          | 6mm Ø | 10mm Ø  | 20mm Ø   |
| 3mm Ø          | 7mm Ø | 11mm Ø  | 25.4mm Ø |
| 4mm Ø          | 8mm Ø | 12mm Ø  |          |

Sold by the Metre.

A precision extruded round rubber cord used for making O rings. Our Nitrile Rubber O Ring Cord is black, has a hardness of 70 Duro and exhibits good resistance to fuels, greases and mineral oil fluids.

## Silicone O Ring Cord, 60 Duro



|                        |                 |
|------------------------|-----------------|
| Temperature Resistance | -60°C to +230°C |
| Colours                | Red, White      |
| Polymer                | Silicone        |
| Hardness               | 60 Shore A      |

| Standard Sizes White Silicone |         |          |       |
|-------------------------------|---------|----------|-------|
| 1.5mm Ø                       | 2mm Ø   | 3mm Ø    | 5mm Ø |
| 1.78mm Ø                      | 2.4mm Ø | 3.53mm Ø | 8mm Ø |

| Standard Sizes Red Silicone |          |        |        |
|-----------------------------|----------|--------|--------|
| 6.4mm Ø                     | 9.5mm Ø  | 14mm Ø | 22mm Ø |
| 7mm Ø                       | 10mm Ø   | 16mm Ø | 25mm Ø |
| 8mm Ø                       | 12.7mm Ø | 19mm Ø | 30mm Ø |

Sold by the Metre.

High quality extruded silicone O Ring Cord in a selection of sizes.

This high performance sealing rubber is able to withstand high heat (260°C short-term) and is compatible with a vast array of chemicals and fluids.

## Viton O Ring Cord, Black 70 Duro



|                        |                 |
|------------------------|-----------------|
| Temperature Resistance | -15°C to +260°C |
| Colour                 | Black           |
| Polymer                | Viton FKM       |
| Hardness               | 70 Shore A      |

| Standard Sizes |         |          |          |
|----------------|---------|----------|----------|
| 3.2mm Ø        | 5mm Ø   | 8mm Ø    | 14.2mm Ø |
| 3.5mm Ø        | 6.4mm Ø | 9.5mm Ø  | 15mm Ø   |
| 4.8mm Ø        | 7mm Ø   | 12.7mm Ø | 19mm Ø   |

Sold by the Metre.

A very high quality, industrial-grade O Ring Cord that combines excellent temperature resistance, chemical resistance and seal performance.

## Moulded O Ring Packs, O Ring Making Kits & More.

In addition to our wide range of O Ring Cords, we are very pleased to offer a selection of O Ring Packs (in metric and imperial sizes) and our O Ring Bonding Kits that include everything you need to make your own custom O Rings (incl. Glue, Primer, Cord and Accessories).

We can also help with producing O Rings upon request. For information on our kits, packs, O Ring Cords and more, please click the link below.



## Spiral Wound Gaskets, Style WR

Style WR Spirals are made with a sealing component (metallic windings and a flexible, non-metallic filler) and an additional, solid metal outer ring.

The outer ring (also known as a centring ring or guide ring) centres the gasket on the flange and sits flush with the bolts.

It also acts as an anti-blowout device, provides radial support to the sealing components and acts as a compression stop to prevent the windings and filler being crushed due to over tightening of the bolts.

Most commonly, outer rings are produced from mild steel or stainless steel but can be produced from other metals when required.

The spiral wound gaskets listed on our website all feature a Carbon Steel Guide Ring with 316 Stainless Steel Windings and a Flexible Graphite Filler.

| Spirals to Suit |          |           |
|-----------------|----------|-----------|
| ANSI 150        | ANSI 300 | ANSI 900  |
|                 | ANSI 600 | ANSI 1500 |

| Flange Nominal Bore | Imperial | Flange Nominal Bore | Imperial |
|---------------------|----------|---------------------|----------|
| 15NB                | 1/2"     | 125NB               | 5"       |
| 20NB                | 3/4"     | 150NB               | 6"       |
| 25NB                | 1"       | 200NB               | 8"       |
| 32NB                | 1 & 1/4" | 250NB               | 10"      |
| 40NB                | 1 & 1/2" | 300NB               | 12"      |
| 50NB                | 2"       | 350NB               | 14"      |
| 65NB                | 2 & 1/2" | 400NB               | 16"      |
| 80NB                | 3"       | 450NB               | 18"      |
| 90NB                | 3 & 1/2" | 500NB               | 20"      |
| 100NB               | 4"       | 600NB               | 24"      |

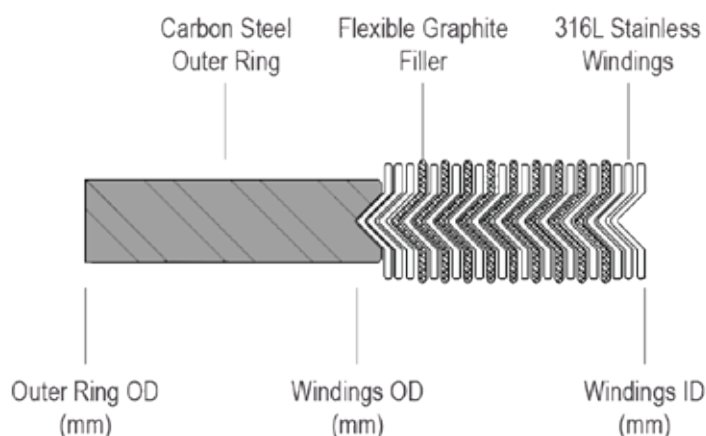

For full tables of dimensions for all WR Type Spiral Wound Gaskets for each of the ANSI Flanges, please visit the link included at the bottom of this page.

## Custom Gaskets

Depending on the material, gaskets & washers can be produced using either precision knife-cutting or water-jet cutting.

The vast, vast majority of our materials are able to be supplied as cut gaskets on request.

Gaskets can be produced to suit your drawings, sketches, dimensions or even from old gasket samples.

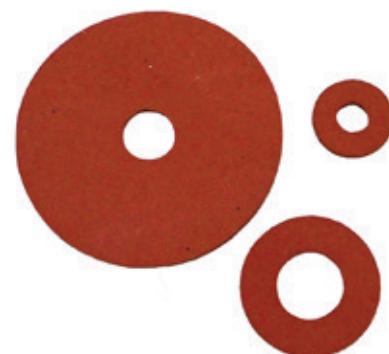

# Fibre Gasket Materials

## Oil Jointing Gasket Paper



|                        |                         |
|------------------------|-------------------------|
| Temperature Resistance | +120°C                  |
| Colour                 | Brown                   |
| Compression            | 25-40%                  |
| Tensile Strength       | 13.79 Mn/m <sup>2</sup> |
| Recovery               | 40% (min.)              |

| Available Thicknesses |       |       |     |
|-----------------------|-------|-------|-----|
| 0.25mm                | 0.5mm | 1mm   | 2mm |
| 0.4mm                 | 0.8mm | 1.5mm | 3mm |

Sold by the Metre.

Used in applications with temperatures up to 120°C and is made from cellulose fibres. It is soft and easy to cut and thanks to its low compression requirements, will affect a seal with less bolt load than many other types of gasket paper or fibre.

## Red Fibre Vulcanised Gasket Sheet



|                        |                         |
|------------------------|-------------------------|
| Temperature Resistance | +10°C to +85°C          |
| Colour                 | Red                     |
| Density                | 1.4gm / cm <sup>3</sup> |
| Base                   | Cellulose               |

| Thicknesses |
|-------------|
| 0.8mm       |
| 1.5mm       |
| 3mm         |

| Standard Sheet Sizes |
|----------------------|
| 295mm x 495mm        |
| 500mm x 1200mm       |
| 1000mm x 1200mm      |
| 1200mm x 2000mm      |

Used in applications with temperatures up to 120°C and is made from cellulose fibres. It is soft and easy to cut and thanks to its low compression requirements, will affect a seal with less bolt load than many other types of gasket paper or fibre.

## Conafi

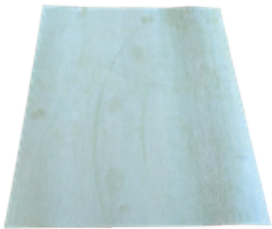

|                        |        |
|------------------------|--------|
| Temperature Resistance | +220°C |
| Colour                 | Green  |
| Max. Pressure          | 6 MPa  |
| Compressibility        | 11.7%  |
| Recovery               | 58.8%  |

| Thicknesses |     |
|-------------|-----|
| 0.8mm       | 3mm |
| 1.5mm       | 5mm |
| 2mm         |     |

| Standard Sheet Sizes |
|----------------------|
| 500mm Square         |
| 1550mm Square        |

Conafi has been developed for industrial sealing applications and will handle up to 220°C. is also well suited to many automotive, marine and domestic applications. These include gaskets for pumps, tanks, flanges and many other applications where various oils, chemicals, gas, salts, alkalis or water needs to be sealed.

## Blackmar

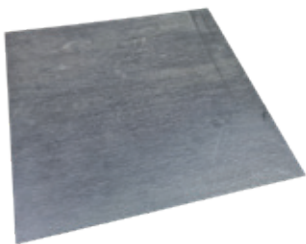

|                        |        |
|------------------------|--------|
| Temperature Resistance | +350°C |
| Colour                 | Black  |
| Max. Pressure          | 12 MPa |
| Compressibility        | 9.9%   |
| Recovery               | 55%    |

| Thicknesses |       |       |
|-------------|-------|-------|
| 0.25mm      | 0.5mm | 1.5mm |
| 0.3mm       | 0.8mm | 2mm   |
| 0.4mm       | 1mm   | 3mm   |

| Standard Sheet Sizes |
|----------------------|
| 500mm Square         |
| 1000mm Square        |
| 1500mm Square        |
| 1550mm x 3100mm      |

A good quality, general-purpose industrial gasket material that covers most sealing applications where CNAF would be used. Blackmar is made with DuPont Kevlar Fibres, Minerals and a Nitrile Rubber Binder. This gasket sheet has excellent chemical resistance. It can be used for sealing fuels, oils, gases, hydrocarbons and lubricants & more.

## C4400 Gasket Material



|                        |        |
|------------------------|--------|
| Temperature Resistance | +175°C |
| Colour                 | Green  |
| Max. Pressure          | 40 Bar |
| Compressibility        | 11%    |
| Recovery               | 55%    |

| Thicknesses |     |
|-------------|-----|
| 0.5mm       | 2mm |
| 1mm         | 3mm |
| 1.5mm       |     |

| Standard Sheet Sizes |
|----------------------|
| 495mm Square         |
| 1000mm Square        |
| 1000mm x 1500mm      |
| 1500mm x 2000mm      |

A universal gasket material with good all-round chemical, fluid, temperature and pressure resistance. Klingsil C4400 Gasket Material is suitable for use in many sealing applications and is available in a selection of thicknesses.

## Alapin Industrial Gasket Material



|                        |        |
|------------------------|--------|
| Temperature Resistance | +340°C |
| Colour                 | Green  |
| Max. Pressure          | 12 MPa |
| Compressibility        | 10%    |
| Recovery               | 55%    |

| Thicknesses |       |
|-------------|-------|
| 0.8mm       | 2.5mm |
| 1mm         | 3mm   |
| 1.5mm       | 5mm   |
| 2mm         |       |

| Standard Sheet Sizes |
|----------------------|
| 500mm Square         |
| 500mm x 1000mm       |
| 1550mm Square        |

A versatile, high quality grade of compressed gasket fibre. Alapin Industrial Gasket Material has very good compatibility with water, oil, fuels, natural gas and a range of other media. Withstands up to 340°C.

## Sigraflex Universal Tanged Graphite

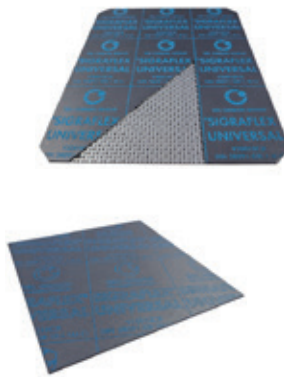

|                        |                  |
|------------------------|------------------|
| Temperature Resistance | -250°C to +450°C |
| Colour                 | Black            |
| Max. Pressure          | 100 BAR          |
| Compressibility        | 40%              |
| Recovery               | 5%               |

| Thicknesses |  |
|-------------|--|
| 1.5mm       |  |
| 2mm         |  |
| 3mm         |  |

| Standard Sheet Sizes |
|----------------------|
| 495mm Square         |
| 1000mm Square        |
| 1500mm Square        |

A premium grade Graphite Gasket Material with a special, 316 Stainless Steel Tanged Reinforcement. Suitable for high pressure (100 BAR) and high temperatures (-250°C to +450°C) and compatible with numerous forms of media and fluids.

## Other Styles of Fibre Gasket Material, Cut Gaskets, Washers & More.

The styles on this page are only a small portion of the full range of gasket materials we offer. This includes various other compressed fibre sheets, graphite based materials and expanded PTFE sheets.

All are available in a variety of thicknesses and sheet sizes and can also be cut into whatever size gasket or washer you require. Many of the more popular gasket configurations can be browsed online (250+ styles available) or contact us for custom sizes.



C6327



Gore GR

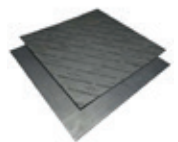

Topgraph 2000



Blue Gylon



Fawn Gylon

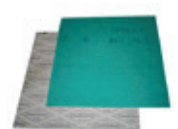

C4430

# Sponge & Foam Sealing Materials

## Adhesive Neoprene Sponge Rubber Sealing Tape (#6100)

|                  |                       |
|------------------|-----------------------|
| Temperature      | -15°C to +105°C       |
| Colour           | Black                 |
| Adhesive Type    | Acrylic               |
| Water-Tight Seal | At 10% Compression    |
| Flame Retardant  | Yes (FMVSS 302)       |
| Density          | 150kg/cm <sup>3</sup> |



An easy to use tape that is perfect for sealing narrow or tight gaps. It achieves water tight seals at just 10% compression, is adhesive backed and provides long lasting performance.

| Available Thicknesses & Roll Lengths |        |        |        |
|--------------------------------------|--------|--------|--------|
| 2mm                                  | 25Mtrs | 9.5mm  | 10Mtrs |
| 3mm                                  | 25Mtrs | 12.7mm | 7Mtrs  |
| 4.8mm                                | 15Mtrs | 19mm   | 7Mtrs  |
| 6.4mm                                | 15Mtrs |        |        |

| Standard Widths |      |      |       |       |
|-----------------|------|------|-------|-------|
| 9mm             | 18mm | 36mm | 75mm  | 125mm |
| 12mm            | 24mm | 48mm | 100mm | 150mm |

Not All Thicknesses Available in All Widths.  
Please Contact Us for Custom Sizes.

## Adhesive PVC Foam Sealing Tape (#3100)

|                  |                       |
|------------------|-----------------------|
| Temperature      | -40°C to +82°C        |
| Colour           | Black / Dark Grey     |
| Adhesive Type    | Acrylic               |
| Water-Tight Seal | At 30% Compression    |
| Flame Retardant  | Yes (FMVSS)           |
| Density          | 120kg/cm <sup>3</sup> |

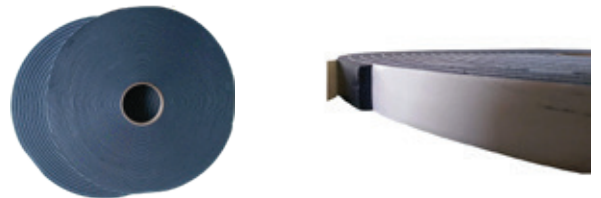

This tape is very easy to work with, suitable for outdoor use and water-tight at 30% compression. It's a little softer than our Neoprene Sponge Tape yet very durable and long lasting.

| Available Thicknesses & Roll Lengths |          |        |         |
|--------------------------------------|----------|--------|---------|
| 3mm                                  | 30.5Mtrs | 9.5mm  | 9.1Mtrs |
| 4.8mm                                | 15.2Mtrs | 12.7mm | 7.6Mtrs |
| 6.4mm                                | 15.2Mtrs |        |         |

| Standard Widths |      |      |       |       |
|-----------------|------|------|-------|-------|
| 9mm             | 18mm | 36mm | 75mm  | 125mm |
| 12mm            | 24mm | 48mm | 100mm | 150mm |

Not All Thicknesses Available in All Widths.  
Please Contact Us for Custom Sizes.

## Neoprene Sponge Sheet, Non-Adhesive

This is an ideal solution for when you need a compressible yet durable sealing material.

It will create water-tight seals, exhibits good resistance to oils and works well for cushioning pads and anti-vibration work.



|             |                       |
|-------------|-----------------------|
| Temperature | +80°C                 |
| Density     | 160 kg/m <sup>3</sup> |
| Colour      | Black                 |

|                        |                    |
|------------------------|--------------------|
| Hardness               | 25 ±5 HS (C Type)  |
| Compression Set        | 25% (Maximum)      |
| Adhesive (If Selected) | Acrylic, One Side. |

| Available Thicknesses |      |      |      |
|-----------------------|------|------|------|
| 2mm                   | 6mm  | 15mm | 30mm |
| 3mm                   | 8mm  | 18mm |      |
| 4mm                   | 10mm | 20mm |      |
| 5mm                   | 12mm | 25mm |      |

## Neoprene Sponge Sheet, Adhesive Backed

Neoprene Sponge with an acrylic adhesive applied to one side.

Easy to handle, cut, fit and install, this closed cell sponge is ideal for a variety of applications.

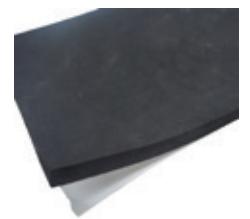



## Ceramic Square Packing



High density, square insulation packing for sealing doors, man-ways and insulating parts.

Our Ceramic Braided Packing will withstand 800°C (or 1200°C in some circumstances).

| Standard Sizes    |                   |
|-------------------|-------------------|
| 10mm <sup>2</sup> | 25mm <sup>2</sup> |
| 13mm <sup>2</sup> | 30mm <sup>2</sup> |
| 20mm <sup>2</sup> | 50mm <sup>2</sup> |

## Ceramic Insulation Rope (Twisted)



A very high temperature insulating rope designed for demanding applications.

Our Twisted Ceramic Insulation Rope withstands up to 1200°C and is available by the metre in a large range of diameters.

| Standard Sizes |          |
|----------------|----------|
| 6mm Dia        | 20mm Dia |
| 12mm Dia       | 25mm Dia |
| 15mm Dia       | 30mm Dia |

## Refrasil Rope Insulation



High density heat resistant rope made from Silica fibres and used for making door seals and gaskets in applications up to 982°C.

Refrasil Rope is extremely durable, strong and very easy to handle.

| Standard Sizes |          |
|----------------|----------|
| 6mm Dia        | 18mm Dia |
| 9mm Dia        | 25mm Dia |
| 12mm Dia       |          |

## Fibreglass Braided Rope Seal High Density



A high density grade of braided heat resistant fibreglass rope.

Available by the metre, this round rope is ideal for making high temperature door, window and access point seals and gaskets.

| Standard Sizes |            |
|----------------|------------|
| 6.4mm Dia      | 19mm Dia   |
| 9.5mm Dia      | 25.4mm Dia |
| 12.7mm Dia     | 32mm Dia   |
| 16mm Dia       | 38mm Dia   |

## Fibreglass Rope Lagging Insulation GFR1



A high temperature insulation rope for wrapping pipes, sealing oven doors and making high temperature gaskets.

Fibreglass Rope Lagging GFR1 is extremely soft and flexible. It withstands up to 550°C.

| Standard Sizes |          |
|----------------|----------|
| 12mm Dia       | 40mm Dia |
| 20mm Dia       | 50mm Dia |
| 25mm Dia       |          |

## Fibreglass Square Packing



Pure Fibreglass Insulation Packing available by the metre.

This high strength square rope is able to withstand temperatures up to 500°C and provides good insulation and sealing performance.

| Standard Sizes    |                   |
|-------------------|-------------------|
| 6mm <sup>2</sup>  | 20mm <sup>2</sup> |
| 8mm <sup>2</sup>  | 25mm <sup>2</sup> |
| 10mm <sup>2</sup> | 32mm <sup>2</sup> |
| 13mm <sup>2</sup> | 38mm <sup>2</sup> |
| 16mm <sup>2</sup> | 50mm <sup>2</sup> |

# Flexible Heat Insulation Cloths & Materials

## Aluminium Foil Coated Fibreglass Insulation Fabric

| Thickness | Width  |
|-----------|--------|
| 0.8mm     | 1220mm |
| 1.6mm     | 1500mm |

Fibreglass Cloth coated on one side with Aluminium Foil. This flexible, durable insulation can withstand 260°C and is ideal for heat resistant sealing & protective applications.

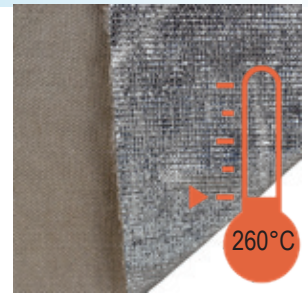

## Irish Refrasil Insulation Cloth

| Thickness | Width |
|-----------|-------|
| 0.71mm    | 838mm |
| 1.47mm    | 838mm |

A premium-grade heat resistant fabric for the most demanding of environments.

Irish Refrasil is a silica cloth that has been specially treated to raise its maximum temperature rating to 1,260°C.

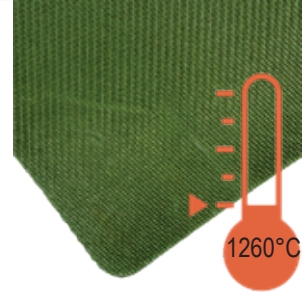

## Aramid Insulation Cloth

| Thickness | Width  |
|-----------|--------|
| 1.5mm     | 1500mm |

Tough, abrasion resistant and strong. Our Aramid Insulation Cloth has excellent physical and mechanical strength yet is flexible enough to be folded, wrapped or sewn with ease.

Withstands 340°C and available by the metre.

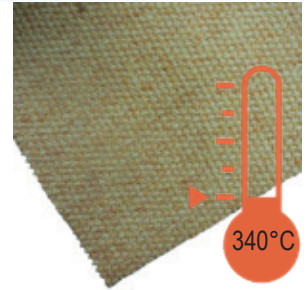

## Silica Insulation Cloth with Black Oxide Coating

| Thickness | Width |
|-----------|-------|
| 1.5mm     | 914mm |

A black, woven fabric designed for extreme heat.

Our Black Silica Insulation Cloth is able to withstand temperatures up to 982°C, provides excellent insulation performance and helps reduce glare.



| Material                               | Base Fibre      | Coating(s)                      | Colour(s)       | Max. Continuous Temp. |
|--|-----------------|---------------------------------|-----------------|-----------------------|
| Aluminium Foil Faced Fibreglass        | Fibreglass      | Aluminium, One Side             | Aluminium & Tan | 260°C                 |
| Aramid Insulation Cloth                | Aramid          | None                            | Yellow(ish)     | 340°C                 |
| Blue Vertex                            | Fibreglass      | Vertex                          | Blue            | 540°C                 |
| Irish Refrasil                         | Silica          | Proprietary                     | Green           | 1,260°C               |
| Premium Quality Woven Fibreglass       | Fibreglass      | None                            | White           | 540°C                 |
| PTFE Coated Glass Fabric - Adh. Backed | Fibreglass      | PTFE, Both Sides                | Brown           | 260°C                 |
| PTFE Coated Glass Fabric - Non-Adh.    | Fibreglass      | PTFE, Both Sides                | Brown           | 260°C                 |
| Refrasil Abrasion Resistant Cloth      | Silica          | Abrasion Resistant Coating      | Orange          | 982°C                 |
| Rewettable Fibreglass Cloth            | Fibreglass      | Rewettable Adh, Water-Activated | White           | 540°C                 |
| Silica Insulation Cloth Black Oxide    | Silica          | Oxide                           | Black           | 982°C                 |
| Silicone Coated Fibreglass Cloth       | Fibreglass      | Silicone Rubber                 | Red             | 230°C                 |
| Superwool Plus                         | Insulation Wool | None                            | White           | 1,200°C               |

# Flexible Heat Insulation Cloths & Materials

## Blue Vertex Coated Fibreglass Cloth

| Thickness | Width(s)       |
|-----------|----------------|
| 0.8mm     | 1000mm         |
| 1.6mm     | 1000mm, 1500mm |

Made from Premium Grade Fibreglass Fabric which is then coated with a proprietary Blue Vertex Finish. This high-quality insulation fabric has enhanced strength and improved resistance to flame & molten metal splash.

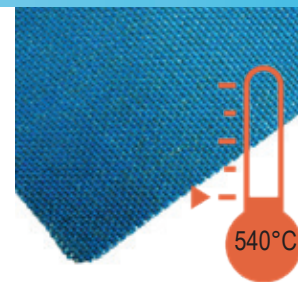

## Silicone Coated Fibreglass Cloth, Red

| Thickness | Width  |
|-----------|--------|
| 1.6mm     | 1500mm |
| 3mm       | 1500mm |

A hybrid material that is made from a base layer of fibreglass fully coated on both sides with high temp silicone elastomer. Our Silicone Coated Fibreglass Cloth withstands high temperatures and is flexible, strong and easy to work with.

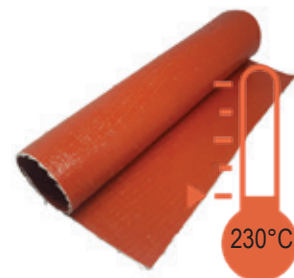

## Premium Quality Woven Fibreglass Cloth – Plain Weave

| Thickness | Width  |
|-----------|--------|
| 2.77mm    | 1000mm |

A 2.77mm thick grade of premium fibreglass cloth with a white loom state finish.

Ideal for making high strength, high temperature welding blankets, covers, pipe wraps and more.

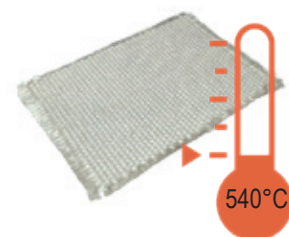

## Refrasil Abrasion Resistant High Temperature Cloth

| Thickness | Width |
|-----------|-------|
| 0.8mm     | 914mm |
| 1.5mm     | 914mm |

Made from Silica, our Abrasion Resistant Refrasil Cloth withstands temperatures up to 982°C.

This tough, long lasting thermal insulation material is very long lasting, easy to work with and versatile.



## Superwool Plus Insulation Blanket

Flexible, easy to work with and long lasting insulation wool. Superwool Plus Insulation Blankets withstand up to 1200°C and provide very good insulation performance.

These soft, compressible insulating batts effectively limit heat transfer and are used for all kinds of domestic and heavy duty industrial applications.

We are pleased to offer our Superwool Insulation Blankets either in full rolls or by the metre.

We can also supply custom fabricated parts on request.

|   |                     |
|---|---------------------|
| Density                                 | 96kg/m <sup>3</sup> |
| Colour                                  | White               |
| Adhesive                                | No                  |
| Tensile Strength<br>Varies on Thickness | 55 - 90 kPa         |
| Temperature Rating                      | 1200°C              |

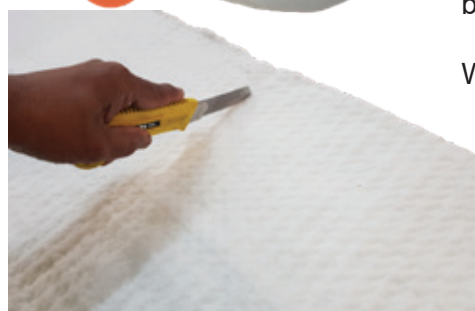

| Thickness | Width | Full Roll Length |
|-----------|-------|------------------|
| 13mm      | 610mm | 14.64Mtrs        |
| 25mm      | 610mm | 7.32Mtrs         |
| 50mm      | 610mm | 3.66Mtrs         |

# Heat Insulation Tapes

## Aramid Insulation Tape



|                      |       |
|----------------------|-------|
| Max. Temperature     | 649°C |
| Abrasion Resistance  | Good  |
| Weight Loss at 340°C | 2%    |

| Thickness | Width |
|-----------|-------|
| 0.8mm     | 25mm  |
| 0.8mm     | 50mm  |
| 1.5mm     | 25mm  |
| 1.5mm     | 50mm  |
| 3mm       | 25mm  |
| 3mm       | 40mm  |
| 3mm       | 50mm  |
| 3mm       | 75mm  |

A light, flexible and extremely tough cloth.

Aramid fibre tape withstands temperatures up to 340°C and provides excellent resistance to abrasion and tearing. Available by the Metre or in 30Mtr Rolls.

## Basalt Insulation Tape



|                          |           |
|--------------------------|-----------|
| Max. Temperature         | 649°C     |
| Abrasion Resistance      | Excellent |
| Acid & Alkali Resistance | Excellent |

| Thickness | Width |
|-----------|-------|
| 1.6mm     | 25mm  |
| 1.6mm     | 50mm  |
| 1.6mm     | 75mm  |
| 1.6mm     | 100mm |

A tough, strong high temperature insulation tape made from Basalt. Basalt Insulation Tape provides excellent thermal insulation performance in temperatures up to 649°C

## Refrasil Silica Insulation Tape

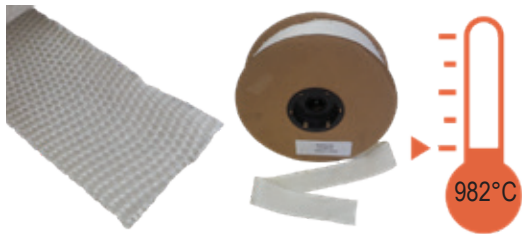

|                              |          |
|------------------------------|----------|
| Max. Temperature             | 982°C    |
| Melting Point                | >1,650°C |
| Silica Content of Base Fibre | 96% Min. |

| Thickness | Width |
|-----------|-------|
| 1.5mm     | 25mm  |
| 1.5mm     | 50mm  |
| 3.2mm     | 25mm  |
| 3.2mm     | 50mm  |

Woven silica insulation tape by the metre. Designed for continuous service in applications up to 982°C (1800°F). Refrasil Tapes are industrial grade heat insulation tapes for the most demanding of applications.

## Silicone Coated Fibreglass Insulation Tape

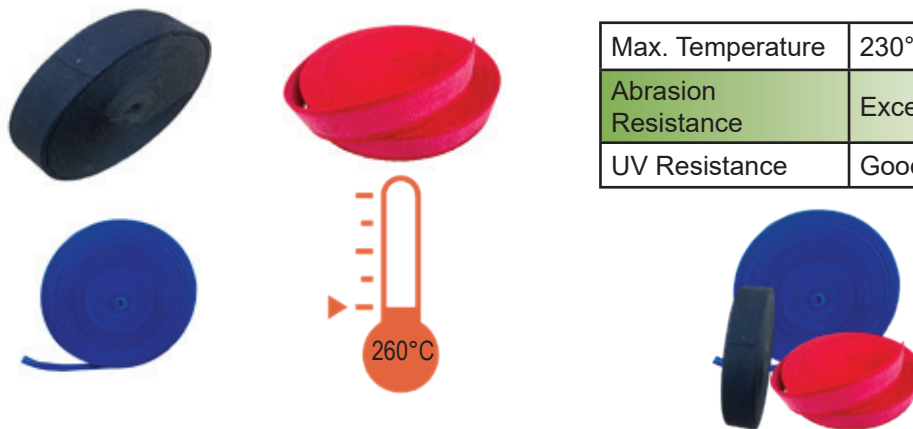

|                     |           |
|---------------------|-----------|
| Max. Temperature    | 230°C     |
| Abrasion Resistance | Excellent |
| UV Resistance       | Good      |

| Thickness | Width | Colour |
|-----------|-------|--------|
| 1.6mm     | 50mm  | Black  |
| 1.6mm     | 75mm  | Black  |
| 1.6mm     | 150mm | Black  |
| 3.2mm     | 50mm  | Red    |
| 3.2mm     | 75mm  | Red    |
| 3.2mm     | 100mm | Red    |
| 6.4mm     | 25mm  | Blue   |
| 6.4mm     | 50mm  | Blue   |

Premium quality fibreglass cloth coated on both sides with a cured silicone finish.

These high temperature, non-adhesive tapes withstand 250°C, abrasion, moisture and most chemicals.

## Fibreglass Exhaust Wrap Insulation Tape



|                     |         |
|---------------------|---------|
| Max. Temperature    | 550°C   |
| Strength at 400°C   | 50%     |
| Abrasion Resistance | Average |
| Chemical Resistance | Good    |

| Thickness | Width |
|-----------|-------|
| 1.5mm     | 50mm  |
| 1.5mm     | 75mm  |
| 3mm       | 25mm  |
| 3mm       | 40mm  |
| 3mm       | 50mm  |
| 3mm       | 75mm  |

Capable of withstanding ongoing exposure to up to 550°C, Fibreglass Exhaust Wrap Tape is flexible, strong and easy to work with.

## Fibreglass Ladder Tape

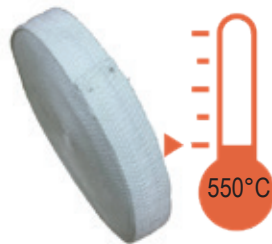

|                     |         |
|---------------------|---------|
| Max. Temperature    | 550°C   |
| Strength at 400°C   | 50%     |
| Abrasion Resistance | Average |
| Chemical Resistance | Good    |

| Thickness | Width |
|-----------|-------|
| 3mm       | 25mm  |
| 3mm       | 40mm  |
| 3mm       | 50mm  |
| 3mm       | 75mm  |
| 3mm       | 100mm |
| 6mm       | 50mm  |
| 6mm       | 75mm  |

A specialised high temp. tape made to allow for bolts to be pushed through the centre.

Fibreglass Ladder Tape withstands 550°C and is ideal for furnace and oven door sealing and other kinds of high heat insulation work.

## Rewettable Fibreglass Cloth Lagging



|                              |               |
|------------------------------|---------------|
| Max. Temperature             | 540°C         |
| Warp Strength                | 45.4kg / 25mm |
| Chemical Resistance          | Excellent     |
| Sunlight & Ageing Resistance | Excellent     |

| Thickness      | Width |
|----------------|-------|
| 0.6mm          | 150mm |
| 10 Metres Long |       |

Contact Us  
for Custom Sizes

Convenient, easy to use pre-slit rolls of our Rewettable Fibreglass Cloth Lagging. These rolls can be wet, wrapped around parts and set hard for permanent heat insulation and protection. They resist up to 540°C.

## Other Styles of Heat Insulation Tapes & Custom Options.

The tapes presented here are just a portion of the variety we stock. Other styles include Ceramic Insulation Tapes, Premium Grade Fibreglass, thin Adhesive Fibreglass and many different types of hybrid, coated thermal insulation tapes.

We also produce a number of different heat insulation tapes in-house. This is best exemplified by our own Tadpole Tape (pictured on the right). Alternatively known as door seal tape, this high quality insulator is typically used for sealing around oven doors with the bulb doing the sealing.



# Heat Resistant Sleeving & Tube

## Refrasil Silica Sleeving



|                        |          |
|------------------------|----------|
| Max. Temperature       | 982°C    |
| Melting Point          | >1,650°C |
| Silica Content of Base | 96% Min. |
| Colour                 | White    |

| Sleeving Diameter | Wall Thickness |
|-------------------|----------------|
| 9.5mm Ø           | 1.65mm         |
| 12.7mm Ø          | 1.65mm         |
| 19mm Ø            | 0.81mm         |
| 25.4mm Ø          | 1.65mm         |
| 38.1mm Ø          | 0.81mm         |
| 38.1mm Ø          | 1.65mm         |
| 50.8mm Ø          | 1.65mm         |
| 63.5mm Ø          | 0.81mm         |

Refrasil Sleeving is flexible, easy to install and long lasting.

Refrasil Silica Sleeving will withstand 982°C (1,800°F). Perfect for protecting cables, hoses and pipes in high heat applications.

## Fyrejacket - Silicone Coated Fibreglass Sleeve



|                       |                             |
|-----------------------|-----------------------------|
| Max. Temperature      | -54°C to +260°C             |
| Wall Thickness        | 3.2mm                       |
| Dielectric Properties | Excellent                   |
| Colour                | Red Outside<br>White Inside |

| Sleeving Diameter |
|-------------------|
| 12.5mm Ø          |
| 19mm Ø            |
| 25mm Ø            |
| 32mm Ø            |
| 38mm Ø            |
| 50mm Ø            |
| 75mm Ø            |

Tough and extremely durable protective and insulating sleeving. Our Fyrejacket Silicone Coated Fibreglass Sleeving withstands 260°C, has a thick flexible silicone outer layer and is flexible, easy to work with and long lasting with excellent abrasion and chemical resistance.

## Aramid Braided Sleeving



|                     |           |
|---------------------|-----------|
| Max. Temperature    | 340°C     |
| Weave Style         | Braided   |
| Abrasion Resistance | Very Good |
| Chemical Resistance | Good      |
| Cut Resistance      | Excellent |

| Size     |
|----------|
| 6mm Ø    |
| 10mm Ø   |
| 12.7mm Ø |
| 19mm Ø   |
| 25mm Ø   |
| 75mm Ø   |

A tough, strong, heat resistant sleeving for protecting cables, leads, wires and small pipes. Our Aramid Sleeving is made in the USA and has a tight, braided construction yet is highly flexible.

This type of sleeving is resistant to most chemicals though it is not suggest for outdoor use.

## Custom Thermal Insulation Solutions

Sometimes stopping heat transfer requires a combination of materials, and/or something made to size. We can help with this too.

Whether it's creating custom made pump covers or expansion joints, individual welding blankets, or some form of pipe wrap; we're able to assist.

Our wide range of insulation materials and in-house fabrication capabilities ensure we can work out a solution for all the most extreme thermal environments.



## Silicone Bonded Mica Sheet

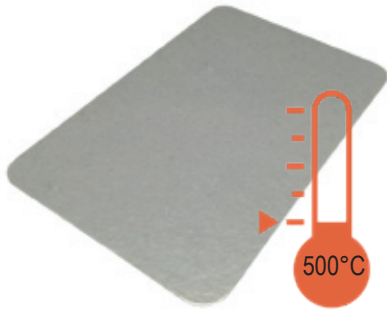

|                             |           |
|-----------------------------|-----------|
| Max. Continuous Temperature | 500°C     |
| Mica                        | Muscovite |
| Compressive Strength        | 350 mPa   |
| Dielectric Strength         | >20 kV/mm |

| Available Thickness |       |     |
|---------------------|-------|-----|
| 0.5mm               | 1.5mm | 4mm |
| 0.8mm               | 2mm   | 5mm |
| 1mm                 | 3mm   | 6mm |

| Standard Sheets |               |                |
|-----------------|---------------|----------------|
| 300mm x 500mm   | 500mm x 600mm | 600mm x 1000mm |

Contact Us for Custom Sizes or Parts.

A silver-grey insulation material with very good temperature tolerance and dielectric strength. Silicone Bonded Mica withstands up to 500°C, can be accurately cut and machined and has a wide range of uses and applications.

## Sindanyo H91 Insulation Board

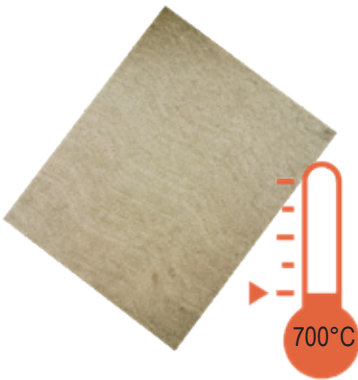

|                             |            |
|-----------------------------|------------|
| Max. Continuous Temperature | 700°C      |
| Compressive Strength        | 90 mPa     |
| Dielectric Strength         | >2.1 kV/mm |

| Available Thickness |      |      |
|---------------------|------|------|
| 6mm                 | 20mm | 50mm |
| 10mm                | 25mm |      |
| 12mm                | 40mm |      |

| Standard Sheets |               |               |
|-----------------|---------------|---------------|
| 200mm x 230mm   | 400mm x 460mm | 600mm x 940mm |
| 940mm x 1245mm  |               |               |

Contact Us for Custom Sizes or Parts.

This tough, rigid thermal insulation material has excellent strength and machinability and is rated for use in applications with continuous temperatures as high as 700°C.

## HST-II GPO1 High Temperature Insulation Board

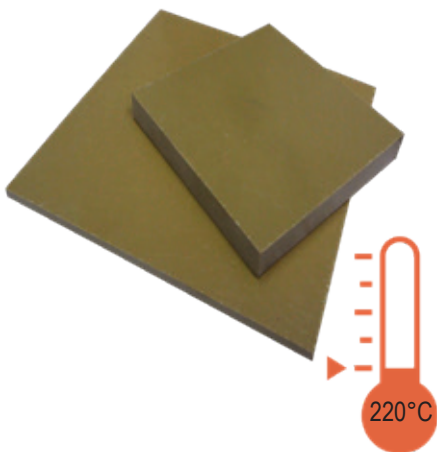

|                             |                        |
|-----------------------------|------------------------|
| Max. Continuous Temperature | 220°C                  |
| Compressive Strength        | 227 mPa                |
| Dielectric Strength*        | 62 kV/mm               |
| Density                     | 1,384kg/m <sup>3</sup> |
| UL Flammability             | UL94                   |
| Arc Resistance              | 150 sec.               |

\*Parallel, Step-by-Step, in Oil

| Available Thickness |        |         |
|---------------------|--------|---------|
| 0.8mm               | 6.4mm  | 25.4mm  |
| 1.6mm               | 8mm    | 31.75mm |
| 2.4mm               | 9.5mm  | 38.1mm  |
| 3.2mm               | 12.7mm | 50.8mm  |
| 4.8mm               | 19mm   |         |

| Standard Sheets |                 |
|-----------------|-----------------|
| 300mm x 300mm   | 600mm x 600mm   |
| 1200mm x 1200mm | 1200mm x 2400mm |

Contact Us for Custom Sizes or Parts.

A strong, rigid electrical insulation material that can withstand temperatures up to 220°C. HST-II GPO1 Insulation Board is used for making high temperature electrical insulation parts.

# Plastic Rod & Tube

## Epoxy / Fibreglass Rod



|                      |                          |
|----------------------|--------------------------|
| Max. Temperature     | 130°C                    |
| Compressive Strength | 2461 kgf/cm <sup>2</sup> |
| Tensile Strength     | 200 kgf/cm <sup>2</sup>  |
| Density              | 1.7 gm/cm <sup>3</sup>   |

| Available Sizes |         |
|-----------------|---------|
| 8mm Ø           | 32mm Ø  |
| 10mm Ø          | 40mm Ø  |
| 12mm Ø          | 50mm Ø  |
| 13mm Ø          | 65mm Ø  |
| 16mm Ø          | 70mm Ø  |
| 18mm Ø          | 80mm Ø  |
| 20mm Ø          | 110mm Ø |
| 22mm Ø          | 130mm Ø |
| 24mm Ø          |         |

A high strength insulating rod with good electrical properties; our Fibreglass Reinforced Epoxy Rod is ideal for making custom insulators and machined parts.

| Standard Lengths |       |
|------------------|-------|
| 490mm            | 980mm |

## Epoxy / Fibreglass Tube



Manufactured from Epoxy Fibreglass Laminate, our Epoxy Glass Tube range presents a great option for all kinds of electrical insulation applications that require a strong, dielectric tube.

These tubes are stocked in a huge range of sizes and can be machined or cut. Our Epoxy Tube is classified as a Class B electrical insulation material, which means it can withstand continuous temperatures of 130°C.

| ID     | OD     |
|--------|--------|
| 10mm Ø | 16mm Ø |
| 10mm Ø | 22mm Ø |
| 12mm Ø | 20mm Ø |
| 12mm Ø | 26mm Ø |
| 13mm Ø | 19mm Ø |
| 16mm Ø | 20mm Ø |
| 18mm Ø | 25mm Ø |
| 19mm Ø | 22mm Ø |
| 19mm Ø | 32mm Ø |
| 19mm Ø | 40mm Ø |
| 20mm Ø | 24mm Ø |

| ID     | OD      |
|--------|---------|
| 20mm Ø | 50mm Ø  |
| 22mm Ø | 25mm Ø  |
| 25mm Ø | 32mm Ø  |
| 25mm Ø | 55mm Ø  |
| 30mm Ø | 40mm Ø  |
| 38mm Ø | 50mm Ø  |
| 38mm Ø | 76mm Ø  |
| 50mm Ø | 76mm Ø  |
| 50mm Ø | 90mm Ø  |
| 75mm Ø | 102mm Ø |
| 90mm Ø | 115mm Ø |

Many More Additional Sizes Available Online.

|                             |                          |
|-----------------------------|--------------------------|
| Max. Continuous Temperature | 130°C                    |
| Compressive Strength        | 700 kgf/cm <sup>2</sup>  |
| Flexural Strength           | 1800 kgf/cm <sup>2</sup> |
| Density                     | 1.4 gm/cm <sup>3</sup>   |

## PTFE Rod, 25% Glass Filled



|                    |                       |
|--------------------|-----------------------|
| Max. Temperature   | 260°C                 |
| Hardness (Shore D) | 60 Duro               |
| Tensile Strength   | > 13 MPa              |
| Specific Gravity   | 2.23g/cm <sup>3</sup> |
| Flammability       | UL 94 V0              |
| Length             | 300mm                 |

| Available Sizes |
|-----------------|
| 25mm Ø          |
| 32mm Ø          |
| 40mm Ø          |
| 50mm Ø          |
| 80mm Ø          |

High quality PTFE Round Bars with Fibreglass Reinforcement. Excellent temperature resistance and improved wear and creep resistance. Our PTFE Rod is used for all kinds of engineering and industrial applications.



## PTFE Sheets - Virgin Teflon



| Available Thickness |       |      |
|---------------------|-------|------|
| 0.15mm              | 2mm   | 6mm  |
| 0.5mm               | 2.5mm | 12mm |
| 1mm                 | 3mm   |      |
| 1.5mm               | 5mm   |      |

|                     |                  |
|---------------------|------------------|
| Flammability        | UL 94-V0         |
| Temperature         | -150°C to +260°C |
| Hardness            | 50-60 Shore D    |
| Tensile Strength    | >20 MPa          |
| Dielectric Strength | >30kV/mm         |

| Standard Sheets    |                    |               |                    |                            |
|--------------------|--------------------|---------------|--------------------|----------------------------|
| 240mm <sup>2</sup> | 495mm <sup>2</sup> | 495mm x 990mm | 990mm <sup>2</sup> | <2mm - Per Mtr 1500mm Wide |
|                    |                    |               |                    | >1.5mm - 1500mm Square     |

This premium grade engineering plastic offers exceptional heat and electrical insulation, unsurpassed chemical resistance and is non-stick with very low friction.

We stock both skived (thinner) and moulded (thicker) types of Virgin PTFE in a huge range of sizes. Custom cut parts available on request.

## PTFE Coated Glass Fabrics

### Adhesive Backed



| Available Thicknesses |
|-----------------------|
| 0.15mm                |
| 0.25mm                |

### Non-Adhesive



| Available Thicknesses |
|-----------------------|
| 0.13mm                |
| 0.25mm                |
| 0.25mm                |

|             |                 |
|-------------|-----------------|
| Roll Widths | 1000mm          |
| Temperature | -72°C to +260°C |

A smooth, non-stick cloth with a silicone adhesive on one side (adhesive backed version).

PTFE Coated Glass Fabric has excellent temperature, chemical and abrasion resistance and can be used in all kinds of applications.

This versatile material is available by the metre. For custom cut parts, please do contact us.

## Polyester Film Sheet

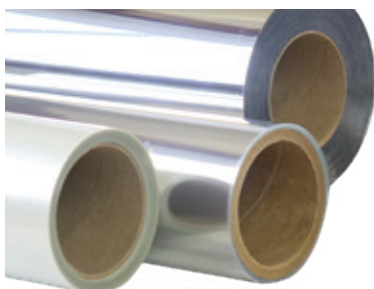

|                             |         |
|-----------------------------|---------|
| Roll Width                  | 1000mm  |
| Max. Continuous Temperature | 150°C   |
| Tensile Strength            | 150 mPa |
| Elongation at Break         | 80%     |

| Available Thickness |         |        |
|---------------------|---------|--------|
| 0.013mm             | 0.076mm | 0.25mm |
| 0.025mm             | 0.1mm   | 0.3mm  |
| 0.04mm              | 0.13mm  | 0.35mm |
| 0.051mm             | 0.188mm |        |

Thin, tough and very strong. Polyester Film is an excellent electrical insulator, has a smooth surface finish, and is available in a selection of (mainly transparent) thicknesses.

## Plastic Shim

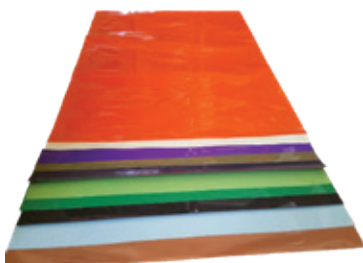

Manufactured with very tight tolerances on thickness, plastic shim is tough, durable and available in a variety of colours.

This shim can be accurately cut and is used in all kinds of domestic and industrial applications.

| Available Thickness |         | Standard Sheets |
|---------------------|---------|-----------------|
| 0.038mm             | 0.254mm | 500mm x 600mm   |
| 0.051mm             | 0.318mm | 500mm x 1270mm  |
| 0.076mm             | 0.381mm |                 |
| 0.1mm               | 0.508mm |                 |
| 0.127mm             | 0.635mm |                 |
| 0.191mm             |         |                 |

# Double Sided, Transfer & Mounting Tapes

## 3M 467MP & 468MP Double Sided Adhesive Transfer Tapes



|                       |  |
|-----------------------|--|
| Colour                | Transparent                                |
| Thickness             | 0.06mm (467MP)<br>0.13mm (468MP)           |
| Adhesive              | 200MP Firm Acrylic                         |
| Temperature           | 40°C to +149°C                             |
| Adhesion to Aluminium | 21 N / 25mm (467MP)<br>32 N / 25mm (468MP) |
| Roll Length           | 55 Metres (467MP)<br>45 Metres (468MP)     |

|                        |
|------------------------|
| <b>Standard Widths</b> |
| 6mm to 400mm           |

Contact Us for Custom Sizes.

Very thin, transparent transfer tapes. 3M 467MP & 468MP work well with a wide range of materials, have excellent temp. resistance and create high strength bonds. These tapes have excellent hot-cold cycle resistance.

## A3200 Clear Double Sided Adhesive Mounting Tape

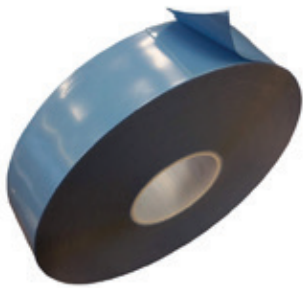

|           |             |
|-----------|-------------|
| Colour    | Transparent |
| Thickness | 1mm         |
| Adhesive  | Acrylic     |

|                             |                |
|-----------------------------|----------------|
| Temperature                 | -35°C to +90°C |
| Adhesion to Stainless Steel | 1770 N/m       |
| Roll Length                 | 33 Metres      |

|                        |
|------------------------|
| <b>Standard Widths</b> |
| 12mm to 48mm           |

Contact Us for Custom Sizes.

A clear double sided adhesive tape. A3200 features a strong acrylic core with an acrylic adhesive that bonds to almost all surfaces and only increases in strength over time. The ideal tape for discrete, lasting mounting.

## 3M 4991 VHB Double Sided Adhesive Foam Tape



|                        |             |
|------------------------|-------------|
| Colour                 | Grey        |
| Thickness              | 2.3mm       |
| Adhesive               | Acrylic VHB |
| Temperature            | 93°C        |
| Roll Length            | 33 Metres   |
| <b>Available Sizes</b> | 12mm, 24mm  |

A thick double sided foam tape with 3M's multi-purpose VHB Acrylic adhesive.

This tape creates high strength bonds that can absorb joint movement and also creates watertight seals between bonded surfaces. Suitable for indoors & outdoors.

## Weicon Mounting Tapes

High strength, versatile, permanent mounting tapes made in Germany.

Available in two styles (transparent and grey foam) these tapes are stocked in shorter rolls for quick repairs and smaller jobs.



|                      |
|----------------------|
| <b>Standard Size</b> |
| 19mm x 3 Mtrs        |

## More Double Sided Transfer and Mounting Tapes

This page provides just a small snapshot of our growing range of Double Sided Adhesive Tapes.

A large portion of these are slit to width in-house and are therefore also available in custom width rolls on request. To discuss this option, or for assistance in choosing the best double sided tape for your application please do contact us.

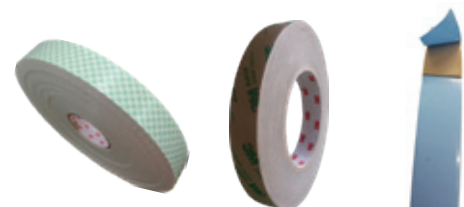

## 3M 2214 Masking Tape

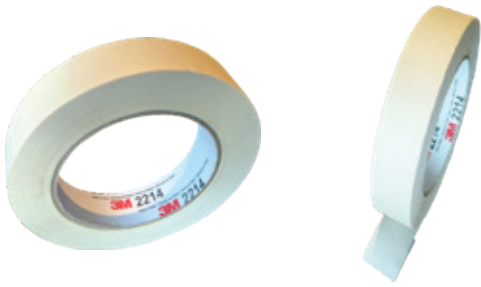

|                     |                          |
|---------------------|--------------------------|
| Backing             | Crepe Paper              |
| Thickness           | 0.14mm                   |
| Adhesive            | Rubber                   |
| Temperature         | 93°C<br>(for 30 Minutes) |
| Elongation at Break | 10%                      |

| Available Sizes        |  |
|------------------------|--|
| 18mm, 24mm, 36mm, 48mm |  |

An economical yet reliable grade of masking tape. Manufactured by 3M, this tape bonds well, is very flexible and can easily be applied to most shapes and surfaces. It can be torn by hand and removes cleanly.

## 3M 301+ Yellow Performance Masking Tape

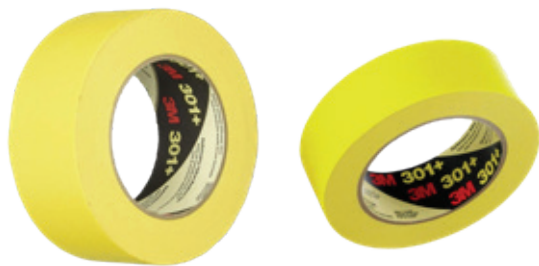

|                     |                           |
|---------------------|---------------------------|
| Backing             | Crepe Paper               |
| Thickness           | 0.16mm                    |
| Adhesive            | Rubber                    |
| Temperature         | 107°C<br>(for 30 Minutes) |
| Elongation at Break | 12%                       |

| Available Sizes        |  |
|------------------------|--|
| 18mm, 24mm, 36mm, 48mm |  |

An industrial strength tape that is great for paint masking and resists bleed-through. The strong adhesive ensures the tape sticks to a range of surfaces, including metal, rubber, glass and plastic.

## 3M Scotch 233+ Masking Tape



|                     |                           |
|---------------------|---------------------------|
| Backing             | Crepe Paper               |
| Thickness           | 0.17mm                    |
| Adhesive            | Rubber                    |
| Temperature         | 121°C<br>(for 30 Minutes) |
| Elongation at Break | 10%                       |

| Available Sizes |                           |
|-----------------|---------------------------|
| Fineline        | 3mm                       |
| Standard        | 18mm, 24mm,<br>36mm, 48mm |

Easy to apply, remove and extremely conformable. 3M Scotch 233+ Performance Masking Tape has good adhesion, resists paint bleed through and results in clean lines for professional results.

## 3M 471 Vinyl Lane Marking Tape

|             |                 |
|-------------|-----------------|
| Backing     | Pigmented Vinyl |
| Thickness   | 0.14mm          |
| Adhesive    | Rubber          |
| Temperature | 4°C to 77°C     |
| Elongation  | 130%            |

| Standard Widths |
|-----------------|
| 6mm to 75mm     |

Contact Us for Custom Sizes.



A tough, abrasion resistant and long-lasting tape for marking out laneways, floor areas, colour coding and bundling.

This tape has a good, strong rubber-based adhesive and is easy to apply.

# Reflective Tapes & Cloth Tapes

## 3M 3930 Class 1 Prismatic Reflective Tape



|                  |                       |
|------------------|-----------------------|
| Standard Widths  | 24mm, 36mm, 48mm      |
| Standard Lengths | 5 Metres, 45.7 Metres |

Contact Us for Custom Sizes.

A class 1 reflective tape with outstanding durability and reflection. 3M 3930 HIP Reflective Tape is available in a selection of sizes and three high contrast colours. Ideal for traffic signs, vehicle identification and wider angle light reflection.

## 5007 Class 2 Striped Engineering Reflective Tape



|                  |                       |
|------------------|-----------------------|
| Standard Widths  | 24mm, 36mm, 48mm      |
| Standard Lengths | 5 Metres, 45.7 Metres |

Contact Us for Custom Sizes.

An economical grade of long lasting tape. 5007 works well indoors and outdoors and features a long lasting adhesive. It's ideal for vehicle marking, traffic, road and work signs and marking hazards (especially those that must be visible at night).

## Adhesive Book Binding Cloth Tape (#105)

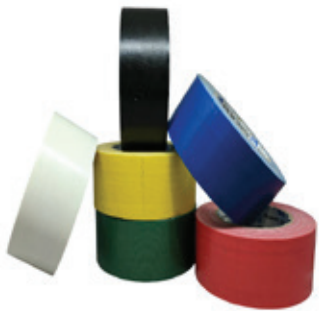

|          |   |
|----------|---|
| Backing  | Waterproof, Polyethylene Coated Rayon Cloth |
| Adhesive | Acrylic                                     |

|             |           |
|-------------|-----------|
| Temperature | 60°C      |
| Elongation  | 10%       |
| Roll Length | 25 Metres |

A tough, strong and economical grade of adhesive cloth tape.

This tape is widely used for binding books, waterproofing, colour coding, bundling and many more applications in the DIY and industrial sectors.

|                       |
|-----------------------|
| 48mm Wide x 25 Metres |
|-----------------------|

## Nashua Gaffer Tape #357 Black

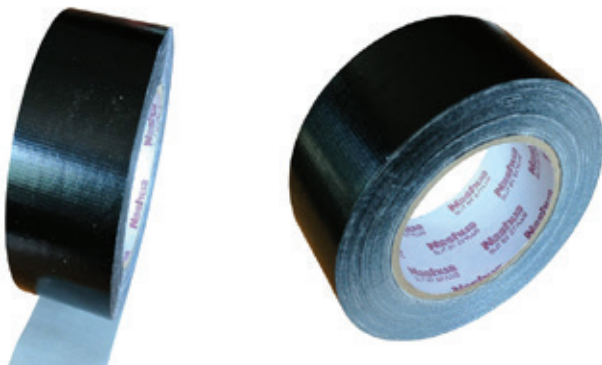

An extremely tough and strong tape with a high-bond adhesive that sticks to almost anything.

Nashua brand Gaffer Tape is ideal for permanently securing objects or covering up leads or cables to prevent trip hazards.

Widely used everywhere from the entertainment industry to workshops and heavy duty applications.

|                       |
|-----------------------|
| 48mm Wide x 40 Metres |
|-----------------------|

# Specialised Industrial Tapes & Accessories

## Petro Tape ST



|               |                |
|---------------|----------------|
| Tear Strength | 35.8 N         |
| Temperature   | -10°C<br>+50°C |

|              |           |
|--------------|-----------|
| Thickness    | 1.4mm     |
| Service Life | 30+ Years |
| Roll Length  | 10 Metres |

|                              |
|------------------------------|
| <b>Available Widths</b>      |
| 50mm, 75mm,<br>100mm & 150mm |

A quality, reliable tape designed for Corrosion Protection can be used to protect a wide range of pipes, fittings and as an isolation and separating tape for roofing.

## Self Levelling Silicone Self Fusing Tape



High quality Self Levelling Silicone Self Fusing Tape has excellent temperature resistance, dielectric strength and resiliency.

It creates watertight, impenetrable seals and has a triangular cross section for a smooth surface finish.

|             |                                   |
|-------------|-----------------------------------|
| Backing     | Cured Self Fusing Silicone Rubber |
| Temperature | -54°C to +260°C                   |
| Elongation  | 480%                              |

25mm Wide x 11 Metres

## 3M 60 Adhesive PTFE Film Tape



|           |                           |
|-----------|---------------------------|
| Backing   | PTFE Film                 |
| Thickness | 0.102mm                   |
| Adhesive  | Silicone<br>Thermosetting |

|             |              |
|-------------|--------------|
| Temperature | 0°C to 180°C |
| Elongation  | 200%         |
| Roll Length | 33 Metres    |

|                        |
|------------------------|
| <b>Standard Widths</b> |
| 6mm to 50mm            |

Contact Us for Custom Sizes.

A versatile tape made with a non-stick PTFE film on one side and a silicone thermosetting adhesive on the other. Excellent temperature resistance, good adhesion and strong electrical insulation properties.

## Hi-Shrink Polyester Tape, Non-Adhesive

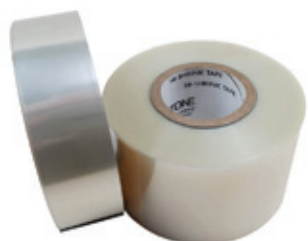

|                     |            |
|---------------------|------------|
| Total Thickness     | 0.05mm     |
| Shrinkage Starts At | 65°C       |
| Shrink Direction    | Lengthwise |

|                |           |
|----------------|-----------|
| Shrinkage      | 20%       |
| Release Coated | No        |
| Roll Length    | 91.4 Mtrs |

|                         |
|-------------------------|
| <b>Available Widths</b> |
| 25mm & 50mm             |

A specialised type of heat shrink tape that is ideal for bundling, forming, debulking and consolidating. Dunstone Hi-Shrink Polyester Tape is manufactured in the USA and is of exceptional, reliable quality.

## Aluminium Foil Tape, Reinforced Premium Grade



|                  |                |
|------------------|----------------|
| Adhesive         | Natural Rubber |
| Tensile Strength | 100 N / 25mm   |
| Elongation       | 25%            |
| Temperature      | -15°C to +65°C |

48mm x 50 Metres

Our Aluminium Foil Tape, Reinforced Premium Grade is a quality grade of foil tape commonly used for securing heat insulation.

## 3M 427 Aluminium Foil Tape



|                  |                 |
|------------------|-----------------|
| Adhesive         | Acrylic         |
| Tensile Strength | 525 N / 100mm   |
| Elongation       | 8%              |
| Temperature      | -54°C to +149°C |

**Standard Widths**

12mm to 100mm

3M 427 Adhesive Aluminium Foil Tape is a high-performance tape used for sealing, bundling and reflecting heat and light.

# Dispensing Equipment & Tools

## Industrial Grade Pump Up Spray Dispenser WPS 1500

| Max Filling Capacity | Max. Working pressure | Container Material         |
|----------------------|-----------------------|----------------------------|
| 1.3 Litres           | 4 BAR                 | Non-Breakable Polyethylene |

Our WPS 1500 is a refillable, professional-grade dispenser used with many different types of liquids. Engineered by Weicon in Germany, it is ideal for reliable spray coverage and dispensing of many kinds of liquid lubricants, cleaners, solvents and coatings.



## Pressurised Air Spray Can WSD 400

| Max Filling Capacity | Max. Working pressure | Container Material |
|----------------------|-----------------------|--------------------|
| 0.4 Litres           | 5 - 10 BAR            | Aluminium          |

A refillable pressurised air spray can be used for dispensing cleaners, lubricants, solvents and other types of technical liquids. WSD 400 is made from toughened Aluminium, is very long lasting and easy to use.



## Professional Grade Caulking Cartridge Gun

A high quality caulking gun designed to make applying silicones, elastic adhesives and polyurethanes easier. This professional grade gun is made from hardened plastic and steel, is lightweight and very easy to use.



## Cartridge Gun for High Viscosity Adhesives

A high quality caulking gun designed for thicker, medium and high viscosity adhesive sealants.

This professional grade gun is made from hardened plastic and steel, is lightweight and very easy to use.



## D 50 Gun for Easy-Mix Adhesives

A professional-grade dispensing tool for our Easy-Mix Adhesive range. Our D 50 Dispensing Gun for Easy-Mix Adhesives is engineered by Weicon in Germany, works with over 10 grades of adhesive and is very easy to use.

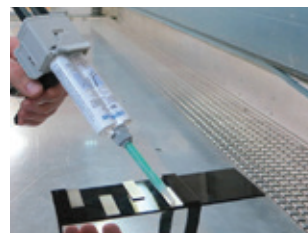

## Flexy Contour Scraper



For applying pasty adhesives and levelling of different compounds.

## Primer Applicator



A simple, easy to use tool to make applying primers a little bit easier.

## Dosing Tips for Super Glues



Reduces wastage and increases accuracy of cyanoacrylate application.

## FingerSaver



A specially developed to keep them out of harm's way when working with flogging spanners, hydraulic torque equipment or impact wrenches.

These tools are made from durable, lasting materials and are designed for the most extreme working environments.

| Model    | Length | Weight |
|----------|--------|--------|
| Compact  | 295mm  | 164gm  |
| Standard | 375mm  | 200gm  |
| Large    | 850mm  | 650gm  |

## Easy Opener Tool

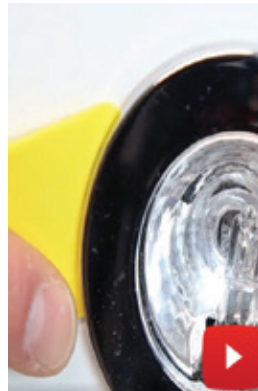

A specially designed tool made for opening sensitive enclosures.

Our Weicon Easy Opener is especially good at opening clipped housings and features 3 different leverage points and a surface that is strong yet flexible enough to not damage surfaces.

Manufactured in Germany from quality materials.

## PVC Flange Spray Shield / Cover



These economical safety shields incorporate a pH indicator for leak identification and are very long lasting solution to protect your personnel, plant and equipment from damage from leaks.

| Standard Sizes |                            |
|----------------|----------------------------|
| Nominal Bores  | 15NB (1/2") to 400NB (16") |
| Flange Tables  | ANSI 150 & ANSI 300        |

|              |   |
|--------------|---|
| Construction | Reinforced PVC with Replaceable pH Indicator Pad in a Clear PVC Pouch |
| Draw String  | Polyester Cord  |
| Temp. Rating | 75°C  |

## Polyester Braided Rope - VB Cord



|                       |                      |
|-----------------------|----------------------|
| Yarn                  | Polyester / PET      |
| Softening Temperature | 225°C (Approx.)      |
| Specific Gravity      | 1.38                 |
| Elongation at Break   | 35% of 8 Strand Rope |
| Construction          | 8 Strand Plait Braid |
| Roll Length           | 100 Metres           |

| Rope Diameters |
|----------------|
| 2mm Ø          |
| 3mm Ø          |
| 4mm Ø          |
| 5mm Ø          |

Our Braided Polyester Rope (also known as VB Cord or venetian blind cord) is a lightweight, high strength rope with a whole range of uses.

This cord is made from 100% polyester yarns that are plait braided into a tough, durable, yet highly flexible cord. It is very strong, has high energy absorption and is not affected by (nor will it absorb) water.



PTFE Sheet



Page 57

Visit Our Store

99 Harburg Drive  
Beenleigh  
QLD 4207

Cork Gasket Sheets

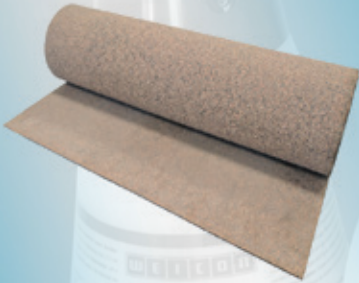

Page 36

Basalt Woven Insulation Tape



Page 52

Mould Release Agent Spray



Page 20

Automatic Wire Stripper No. 5



Page 26

Striped Reflective Tape Class 2



Page 60